

## Educating Television

THE title of this month's comment is ambiguous but we hope that before we have finished the obscurity will have been clarified and the dual meaning established.

In the voluminous evidence submitted both publicly and privately to the Pilkington Committee the quality of television programmes has been the subject of a little praise and much criticism. It would seem that in order to fill the existing channels and transmission time the broadcasting authorities must make use to a considerable extent of routine repetitive material and that this material must be the kind which causes upward trends in the audience research departments' statistical curves. If in the future we are to have, as is technically feasible, three, four or even five alternative programmes, where is the extra programme material to come from? There is little doubt that television audiences already suffer from a surfeit of quiz programmes, lower than top-flight variety shows and "horse operas" and that many licence holders are returning to sound broadcasting, the much maligned "steam radio," for relief. There is, metaphorically, a turn in the tide, a period of slack water which may look dull to lubberly on-lookers on the shore, but which sailors and professional watermen recognize as a period of opportunity for getting things done before the stream takes a new direction and dictates their future movements. In our view the time has come to experiment once again with more programmes of a documentary and "educational" character in peak viewing hours, though they must not be so labelled. With so much emphasis by politicians and the Press on the need for more scientists and technologists the layman's interest and curiosity is already beginning to stir. He would like to know more of what it is all about. Here is an inexhaustible source of arresting programme material—enough to keep a score of programmes going, and without having to pay "star" entertainers' fees. But there must be no attempt to "popularize" or talk down to adult audiences; after all, their mental age is at least as high as the sixth formers whose schools broadcast programmes are enjoyed by many a housewife during the afternoons. The Royal Institution lectures of Sir Laurence Bragg, seen recently in "Science on Saturday" set the

standard by which any future plans might well be judged. We hope that the response to these lectures will help in educating television programme directors to a re-assessment of public taste and interest.

Of the importance of the role of television in educating those who would or must acquire knowledge there can surely now be little doubt. We agree with our contributor "Diallist" (June issue, p. 338) on the distinction between lecturing and teaching and of the value of personal relationships in adjusting the difficulties arising from differences in the rate of absorption of ideas, but the scale of the educational programme and the size of classes does not always permit the achievement of this ideal. Many must reach the end of their schooling half taught and will have to complete their education, as many have done before them, from books. Television can not only stimulate but powerfully help them to do so. The television broadcast of a physical experiment is already more convincing than any still picture, and, with colour, the teaching of chemistry and biology will be greatly reinforced.

The way ahead can already be seen in the United States where Educational Television, a non-commercial and widely distributed service, is already being broadcast by more than 50 stations, serving an estimated 70 million people. In sparsely populated areas the service is supplemented by airborne transmitting stations. Outside school hours (6.30 a.m. to 7 a.m. each morning) programmes such as "Continental Classroom" give courses on contemporary mathematics and physics and claim a large following.

Here we have all the clues as to how television can benefit and benefit by education. From the vast store of human knowledge subjects selected primarily to awaken interest can be introduced during peak viewing hours. For those who wish to pursue the matter further, other channels could provide courses for serious study at intermediate and advanced levels, with repeats for the slow learners and even for bright people who do not find the first times of viewing convenient. We are in favour of as many television channels as the spectrum will hold; there should be no difficulty in keeping their programme time fully and beneficially occupied.

# Negative Feedback and Power Output

EFFECT OF NEGATIVE FEEDBACK ON THE OVERLOADING OF A.F. AMPLIFIERS

By S. W. AMOS, \* B.Sc. (Hons.), A.M.I.E.E.

**I**N his article "Negative Feedback and Non-linearity" in the April 1961 issue of the *Wireless World*, Cathode Ray has shown that the effects of negative feedback on distortion caused by curvature of valve characteristics are not so straightforward or so beneficial as might be supposed. In his article "Cathode Follower Distortion" in the following month's issue, Cathode Ray continued his critical appraisal of negative feedback by pointing out that distortion may arise in negative feedback amplifiers if the rise time of signals is short or their frequency high.

This article shows a further limitation of negative feedback which has nothing to do with the curvature of valve characteristics and is not confined to signals of short rise time or high frequency. The effect discussed here would in fact occur with perfect valves (having straight, parallel and equidistant characteristics) and at low frequencies. Briefly the main point of this article is that the application of negative feedback to an amplifier can reduce the maximum undistorted power available from it. Because negative feedback reduces harmonic distortion it might appear that feedback would increase the power output for a given percentage of total harmonic distortion and, in an output stage incorporating a perfect output transformer, this would be true. For practical amplifiers, however, and in particular for the small a.f. amplifiers incorporated in receivers, feedback reduces the power output available.

We will first consider an ideal amplifier containing a single output pentode rated for 10 watts maximum anode dissipation. Such a valve is probably rated by the manufacturers as providing 4.5 watts output at 10% total harmonic distortion. Now suppose negative feedback is applied to the valve and that the input signal is increased to keep the power output constant. By this means it should be possible to obtain the 4.5 watts output at, say, 1% total harmonic distortion and if the input signal is now further increased in amplitude until the distortion again reaches 10%, the power output must exceed 4.5 watts. The increase in power cannot be very great because, for a sinusoidal signal, the maximum efficiency of a class-A stage is 50% and for a 10-watt pentode this corresponds to 5 watts. We would expect, therefore, that negative feedback would enable us to obtain a power output between 4.5 and 5 watts for 10% total harmonic distortion.

In this calculation we did not mention any effects due to the output transformer: in other words we assumed it to be a perfect component with no resistance, with infinite primary inductance and with no

leakage inductance. The effects of the finite primary inductance of a real transformer are considerable, and, in fact, turn the power gain deduced above into a loss.

To understand this consider again the pentode discussed above. Let the h.t. supply be 250 volts and the mean anode current 40mA; this corresponds to the rated maximum anode dissipation of 10 watts. If the knee voltage is taken as 50 volts the maximum undistorted anode voltage swing is 200 volts. The maximum undistorted anode current swing is 40mA and the most efficient use is made of the valve when maximum voltage swing and current swing occur together. This can be assured by using the optimum value of anode load which is given by  $200/(40 \times 10^{-3})$ , i.e., 5,000 ohms. For such a load value the maximum power output is given by

$$P = \frac{V_{pk} I_{pk}}{2}$$

$$= \frac{200 \times 40 \times 10^{-3}}{2}$$

$$= 4 \text{ watts}$$

To obtain this power the load into which the pentode operates must be 5,000 ohms at all frequencies in the passband of the amplifier. Now the resistive anode load is shunted by the reactance of the primary winding of the output transformer and part of the output current of the valve flows in the reactance. This represents a loss of output power because only the current flowing in the resistance load is available as useful power output. The primary reactance is, of course, directly proportional to

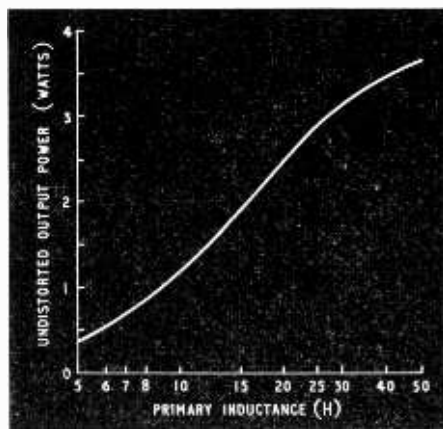

Fig. 1. Dependence on primary inductance of the maximum undistorted output power available at 50c/s from a pentode rated at 10 watts anode dissipation.

\* Engineering Training Department, British Broadcasting Corporation.

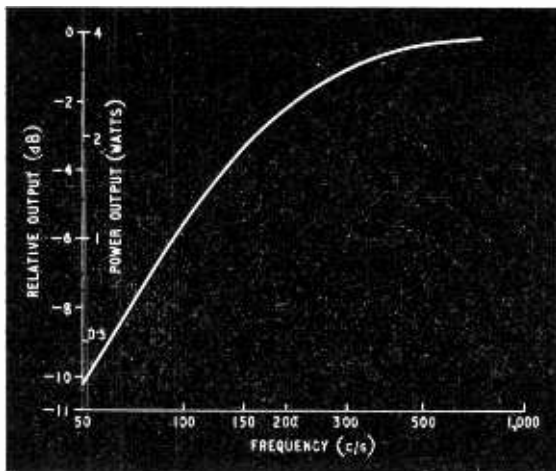

Fig. 2. Illustrating the fall in power output at low frequencies for a primary inductance of 5H.

frequency and this loss is therefore most serious at low frequencies. This reactance causes, in fact, a bass loss the magnitude of which depends on the inductance of the transformer primary.

Suppose we decide that a 3 dB loss can be accepted at 50 c/s: this means that half the output of the valve is lost, half the current flowing in the resistance load and the other half in the shunt reactance. This occurs when the reactance of the primary winding at 50 c/s is equal to the optimum load (5,000 ohms). This gives the primary inductance at 16 H.

A larger value of inductance gives a smaller bass loss and a smaller inductance a greater loss. The small output transformers used in receivers have an inductance of the order of 5 H. This has a reactance of 1,571 ohms at 50 c/s and the signal-frequency output current of 40 mA from the pentode divides, at this frequency, 12 mA flowing in the resistive load and 38 mA in the shunt reactance. These currents are in the ratio 1,571:5,000 and are in quadrature, their sum being given by  $\sqrt{(12^2 + 38^2)} = \sqrt{1600} = 40\text{mA}$ .

The current in the resistance load is thus only 12/40, i.e., 3/10th of the value at higher frequencies, e.g., 1,000 c/s. If the load is a true 5,000 ohm resistance the voltage across the load is also reduced in the same ratio (to 60 volts), and the power output at 50 c/s is only  $(12 \times 10^{-3} \times 60)/2$ , i.e., 0.35 watt. This corresponds to a loss of more than 10 dB compared with the output available at 1,000 c/s. It is surprising to find that the shunting effect of the primary reactance limits the power output at 50 c/s to as little as 0.36 watt. More power could be obtained, of course, by using a larger primary inductance and Fig. 1 illustrates the dependence of power output on inductance. Fig. 2 gives the power output plotted against frequency for a primary inductance of 5 H.

The bass loss of over 10 dB which occurs with 5 H primary inductance is not as obvious in reproduction as might be expected largely because loudspeaker and cabinet resonances tend to hold up the response at low frequencies.

A significant feature of the amplifier is that the output valve overloads at the same amplitude of input signal no matter what the frequency. Thus if the valve

overloads with, say, a signal of 5 volts peak at 1,000 c/s it will also overload with 5 volts at 50 c/s even though the power output is 4 watts at 1,000 c/s and 0.36 watt at 50 c/s.

Now suppose, in an effort to produce a better frequency response than that shown in Fig. 2, that negative feedback is applied to the amplifier. This cannot affect the ratio in which the output current divides between the resistance and the reactance. It corrects the frequency response by increasing the signal applied between grid and cathode as frequency falls so as to maintain constant voltage across the resistance-reactance combination. To obtain a frequency response level down to 50 c/s the feedback circuit increases the grid-cathode signal in the ratio 3.3:1 as frequency falls from 1,000 c/s to 50 c/s, although the input signal to the amplifier remains constant. Suppose the input signal is adjusted to give 0.36 watt output at 50 c/s. What happens as the frequency is increased? The grid-cathode signal falls to 1/3.3 of the value it had at 50 c/s and reduces the output power to  $1/(3.3)^2$ , i.e., 1/11 of the maximum value of 4 watts. This reduced output is, of course, 0.36 watt as would be expected in an amplifier with a level frequency response: in other words for a given voltage input we get the same power output at all frequencies.

But the overload characteristic of this feedback amplifier is quite different from that of the amplifier without feedback. At 50 c/s the amplifier overloads at an input corresponding to 0.36 watt output: at 1,000 c/s it will accept 3.3 times the input, corresponding to an output of 4 watts. Thus the amplifier overloads more readily in the bass than at higher frequencies. This has some significance in the apparent loudness of reproduction at the point where overload distortion is detected. For suppose the amplifier is fed with a signal containing equal-amplitude 50 c/s and 1,000 c/s components. How does feedback affect the ability of the amplifier to handle such a signal? The amplifier without feedback can accept without distortion an input which delivers the maximum output (4 watts) from the 1,000 c/s component and the maximum (0.36 watt) from the 50 c/s component. The amplifier with feedback will also overload when 0.36 watt is delivered from the 50 c/s component but this will coincide with an output also of 0.36 watt from the 1,000 c/s component. Any attempt to obtain more than 0.36 watt from the 1,000 c/s component will result in distortion due to overloading of the 50 c/s component. Although there is no doubt that the feedback amplifier has the better performance it is also true that the amplifier without feedback will produce more power output before distortion becomes apparent.

This argument is, of course, based on the assumption that the input signal has equal-amplitude 50 c/s and 1,000 c/s components. A different answer is obtained if a different amplitude ratio is chosen and thus the importance of this point depends on the relative amplitudes of low-frequency and high frequency components in the sound we are trying to reproduce.

Investigations have been carried out into this subject and, as might be expected, the results show that the distribution of energy over the audible spectrum depends on the type of sound. In many examples of music the amplitude of 50 c/s components is of

the order of 10 dB lower than that of 1,000 c/s components but in other types of music these components can be of equal amplitude and in organ music the 50 c/s components can be appreciably larger in amplitude than the 1,000 c/s components.\* This suggests that the feedback amplifier mentioned above could, on certain samples of music, be operated to give 4 watts output at 1,000 c/s without overloading. For other samples, however (with larger bass components) a much smaller output must be accepted to avoid overloading. To be on the safe side it is best to design equipment to give the required output without distortion when the input has a uniform distribution of energy over the spectrum.

One way of achieving this, of course, is to employ an output transformer of adequate primary inductance but this would be a large and costly component. Another method is to introduce a bass cut in the input to the output stage, the cut being designed so that overloading occurs simultaneously at 50 c/s and 1,000 c/s when these have equal amplitudes in the original input. It might be argued that there is little point in using negative feedback to level the frequency response of the amplifier if the bass cut is to be restored by a circuit ahead of the output stage. Except for improving frequency response however, this arrangement has all the advantages of a feedback amplifier, namely reduction of harmonic distortion, reduction of hum and reduction of output resistance. Alternatively, improved overloading characteristics can be obtained by using only a limited degree of negative feedback (say 6 dB instead

of 20 dB) or by designing the feedback circuit to give a bass cut instead of levelling the frequency response in the bass.

This article has so far dealt with the problems of reproducing middle-frequency and low-frequency signals simultaneously and has shown that the finite shunt reactance of the output transformer primary winding is the chief cause of the difficulties that arise. A similar problem arises in reproducing middle-frequency and high-frequency signals if there is a capacitive reactance in parallel with the load resistance and if this has a reactance at, say, 10,000 c/s which is comparable with the load resistance. Such a reactance may be due to a capacitor across the primary winding of the output transformer: it is quite common to include such a component in circuits incorporating output pentodes. The origin of the distortion can be understood from the following calculation. Suppose the capacitance is 0.01  $\mu$ F: this has a reactance of approximately 1,590 ohms at 10,000 c/s. This is approximately equal to the reactance of a 5 H inductance at 50 c/s. Thus the output current from the valve divides between the shunt reactance and the load resistance in the ratio 5,000 to 1,590 and the maximum power output at 10 kc/s is limited to 0.36 W as explained earlier in the article. Thus if equal amplitude 1 kc/s and 10 /c/s signals are present together in the input, 0.36 W is the greatest undistorted output possible and the application of negative feedback cannot improve this situation. Fortunately there is an easy cure for this form of distortion and that is to connect a resistor in series with the shunt capacitor. If this resistor is made equal to the optimum load resistance of the valve (or larger), the reduction of output power is not so marked.

\* These results are taken from the article by J. G. McKnight "The Distribution of Peak Energy in Recorded Music and its Relation to Magnetic Recording Systems". *Journal of the Audio Engineering Society*, April 1959.

## BRIT.I.R.E. CONVENTION ON

# Radio Techniques and Space Research

LACK of space unfortunately prevents us from even mentioning all the papers given at this convention. In particular we have neglected all non-radio topics (such as satellite launching and other mechanical problems) and also topics (such as noise reduction, microminiaturization, and general reliability) not essentially connected with space. The full papers will, however, be published in the *Journal of the Brit.I.R.E.*

We would like to commend the Institution on the very smooth running of this convention—with one exception, i.e., that many delegates were allowed to read their papers word for word although pre-prints of them were already available, this was unfortunate in view of the shortage of time for discussion.

**Space Measurements from the Ground.**—The use of scattered rather than reflected radiation for observing the whole ionosphere rather than merely that part below the region of maximum ionization has already been mentioned in our November 1960 issue (p. 573) and was discussed at this convention in a paper by Greenhow and Watkins. The echo power gives a direct measure of the electron density, and the Doppler spread of the received wavelengths a measure of the temperature. The density can also be determined from the plasma resonance (and transmission cut-off) frequency,

which could be measured by detecting the narrow lines separated from the main echo by plus and minus this frequency.

Recent techniques in radio astronomy discussed in a paper by Jennison included the intensity type of interferometer. Here the two spaced interferometer aerials are connected to completely separate receivers and detectors. The detector outputs are caused to interfere by cross-multiplication, and their cross-correlation coefficient obtained by dividing the output of the cross multiplier by the product of the r.m.s. values of the two separate detector outputs. This coefficient then gives a measure of the distribution of brightness across the source, and thus its angular diameter. This type of interferometer can be considered as providing a comparison between the noise envelopes at the two aerials.

The interferometric principle of aperture synthesis by which the results which would be given by very large aerials are obtained by combining the results from small aerials which are moved about has already been described in our October 1957 issue (p. 477). The above-mentioned paper by Jennison also showed how this technique can be applied to a radar system (in this case for mapping the moon's surface). The transmitter oscillator phase is made stable over a long train of

pulses so that the relative motion between the earth and moon allows an aperture synthesis to be performed. **Ionospheric Measurements from the Ground Using Satellite Transmitters.**—The use of the Faraday rotation of the plane of polarization of the received signals to give a measure of the total number of electrons up to the transmitter has already been described in our December 1957 issue (p. 578).

The Faraday rotation can be regarded as measuring the difference between the Doppler shift frequencies of the ordinary and extraordinary rays, as was pointed out in a paper by Blythe. The mean of these frequencies provides a much larger and thus more sensitive measure of the total electron content. This mean can be obtained from the Doppler curve of the satellite. This curve mainly depends on the satellite motion but effects due to this may be eliminated by making observations at different frequencies, since the Doppler shift due to satellite motion depends in a different way on the frequency from that due to the total electron content.

**Satellite Tracking.**—The use of radar, interferometer and Doppler shift measurements for tracking satellites has already been described in our December 1957 issue and these methods were reviewed at this convention in a paper by Pressey.

This paper also described a combined radar and interferometer method of tracking passive satellites. The transmitter has a vertically directed fan-shaped beam. As the satellite passes through this beam the angle of the reflected signals is measured by interferometers at two receiving stations several hundred miles apart on either side of the transmitter.

**Radio Measurements from Satellites.**—The extension of radio astronomy measurements down to lower frequencies normally absorbed in the ionosphere is, of course, possible with the aid of satellites, and the use of simple wire dipoles 2×75-ft long for this purpose was described in a paper by Graham Smith.

The gain and directivity of such dipoles can possibly be increased according to a paper by Jennison by taking advantage of the facts that, in the region of decreasing electron density in the upper part of the ionosphere, refraction focuses the beam in the direction of the vertical, and interference from signals reflected from the top of the ionosphere modulates this vertical conical beam pattern by fine conical shell fringes which produce an extremely sharp termination of the edge of the focused cone. The focus angle decreases sharply as the operating frequency approaches the plasma transmission cut-off frequency (from above it). Changes and irregularities in the electron density (and thus the plasma frequency) thus introduce complications, but even so this focusing should give useful increases in aerial gain by factors of ten or so. The fine fringes are, unfortunately, not likely to be of much use because for bandwidths of more than a few kc/s they become smoothed out. The very sharp edge of the reception pattern (even for fairly wide bandwidths) could possibly be taken advantage of in two ways. In the first of these the detected output is low-pass limited at an upper frequency which is adjusted according to the fastest rate of change of signal that could be caused by a point source entering the edge of the reception cone as the satellite orbits. This eliminates the large component of background radiation from other sources. Alternatively, the receiver could be rapidly switched between two similar frequencies, the difference in the two outputs so produced then corresponding to the signal from a narrow ring.

By measuring the frequency below which the natural background is cut-off (plasma frequency) the electron density in the neighbourhood of the satellite can also be determined.

A paper by Boyd discussed the use of current/voltage curves from Langmuir probes for measuring electron and ion concentrations and temperatures. The standard laboratory techniques are complicated in space by the effects of satellite motion both on its potential

(which must be used as a reference, there being no "earth" available) and also on ion velocities, the problem of returning the collected charge to the ionosphere and photo-emission. Photo-emission currents can be eliminated and the electron and ion currents separated by using an additional grid in the probe. Photo-emission and ion currents can also, since they are nearly constant, be eliminated by modulating the probe voltage. By modulating this voltage at two frequencies, the electron temperature can be measured directly. The ratio of the current amplitude to depth of modulation (of one frequency upon the other) is measured. It can be shown that this is proportional to the ratio of the first and second differentials of probe current with voltage, and thus also to the electron temperature.

**Satellite Communication.**—The use of a few satellites in an equatorial orbit at such a distance (22,300 miles) that they rotate round the earth once every 24 hours and thus appear stationary relative to the earth was first suggested by Clarke in 1946 and has since been widely discussed. This system has, however, the following disadvantages: projecting a satellite to this altitude is very costly and the payload which can, at present, be placed in orbit is very small, if the "stationary" feature of the orbit is to be fully exploited the satellite must be placed accurately in orbit and must contain altitude stabilizing and station keeping equipment (with its attendant reliability problems), destruction of even one satellite would completely disrupt the service, at this range transmission and reception problems become acute and the use of passive repeaters can in practice be ruled out, and finally, increased noise is produced by transmission through interplanetary plasmas. Several of these disadvantages are avoided by the other often-proposed communication system using a considerably larger number of satellites in a much lower orbit. This system brings, however, its own attendant disadvantages, viz., as a result of the high satellite speeds complicated tracking equipment must be used and the Doppler frequency shift must be allowed for, complications due to having to change from one satellite to another, and finally the satellite environment (partly in the van Allen belts of charged particles) may cause greater deterioration of its equipment. A sort of compromise between these two systems using a few satellites near their furthest distance (about 12,500 miles) in a highly elliptical orbit was described in a paper by Buss and Milburn.

The operating frequency will probably be somewhere in the broad band between the maximum frequency at which ionospheric losses are serious (about 100Mc/s) and the minimum frequency at which atmospheric absorption can become serious (about 7,000Mc/s), since, if one of the new low-noise devices is used, the variation of receiver noise with frequency will not affect the choice of frequency.

The maximum possible satellite weight will limit the transmitter power to a few watts. A usable signal-to-noise ratio can then probably only be obtained with a modulation system in which increased signal to noise can be exchanged for increased bandwidth. This suggests the use either of some sort of pulse coding, probably in binary form by 180° shifts in the phase of the transmitter carrier, or alternatively (or in addition) frequency modulation.

With frequency modulation, which is often proposed because the techniques required are well known, a bandwidth or the order of tens of Mc/s would be required for a 600-channel telephone system. In this case the noise in the corresponding wideband receiver would be prohibitive. A narrow-band receiver can, however, be used provided its local oscillator is phase locked to the incoming sub-carrier.

The use of the moon as a passive reflector was discussed in a paper by Webster. Useful signal to noise ratios can be obtained with transmitter powers of the order 5kW and aerial diameters of the order of 50ft. Unfortunately scattering produced by the uneven surface of the moon limits the usable bandwidth to a few kc/s.

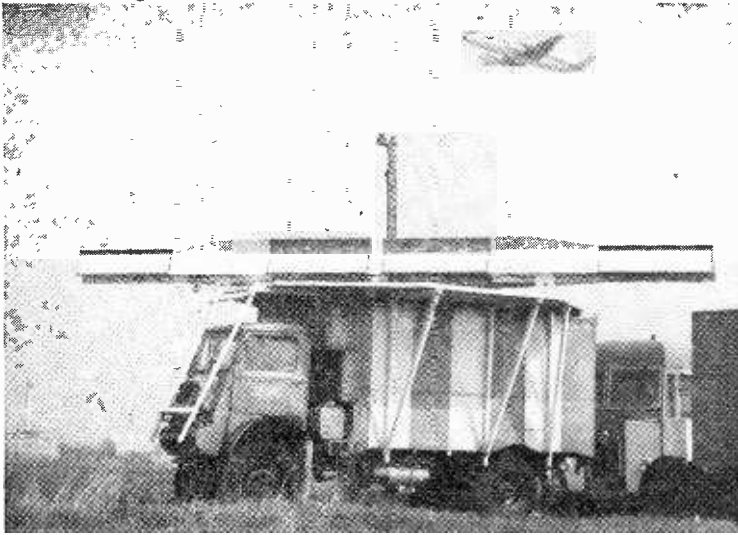

Experimental installation of S.S.R.4G. One masking aerial is in centre of long interrogator array (below obstruction light), other is at back of main array. Splitting of interrogator array rendered design so difficult that computer was used: strip-line feeds are employed to 48 unipoles to give  $2\frac{1}{2}^\circ$  beam width.

EXPERIMENTAL INSTALLATION  
FOR OPERATIONAL  
EXPERIENCE

## Secondary Radar at London Airport

**A**IR TRAFFIC control poses some problems not easily answered by primary radar in spite of the highly sophisticated systems that have been developed: it cannot, for instance, automatically identify a particular aircraft or give to the ground controller the accurate height information known in

the aircraft. One facility that civil a.t.c. has—a facility hitherto neglected apart from R/T contact—is that it can enlist the co-operation of the controlled aircraft.

For many years\* Cossor have been developing, as a private venture, secondary radar—in which a signal from the ground causes a transmitter in the aircraft to “reply”—for a.t.c. purposes and recently a demonstration of their latest equipment which meets, and indeed, formed the basis for, the I.C.A.O. requirements, was given at London Airport. The S.S.R.4G ground equipment employs pulse transmission from a highly directional aerial (which can be rotated in synchronism with a primary radar aerial so that the information gained can be correlated

\* See, for instance, “Secondary Surveillance Radar,” by D. A. Levell, *Wireless World*, Vol. 60, p. 227 (May, 1954).

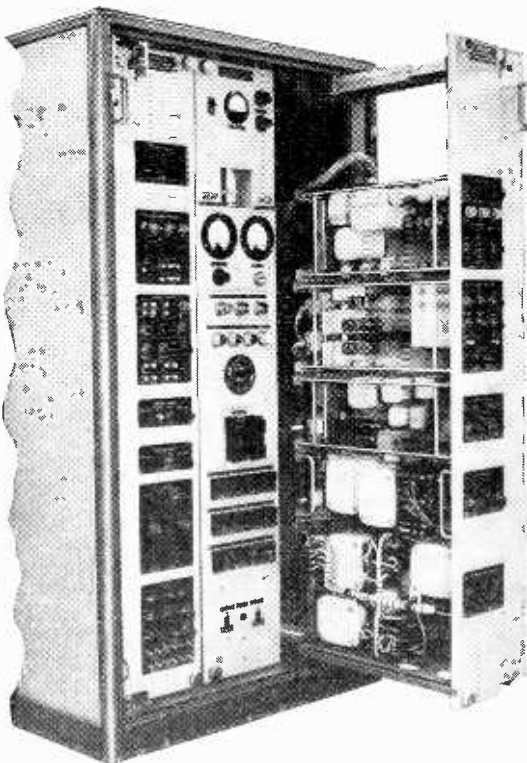

Above: Airborne-transponder control-box with manual code-selection facilities.

Left: Ground-equipment racks—chassis pulled out are aerial-synchronizing circuits, in centre is power supply, on left are 1,000-Mc/s crystal-controlled transmitters, receiver and mode-generating circuits.

easily) and a "covering" aerial whose signal masks the side lobes of the directional array. When the airborne transponder equipment (Type S.S.R.2A) receives pulses with the correct amplitude and time relation it transmits a train of pulses back to the ground equipment.

This train consists of two framing pulses marking the beginning and, normally, the end of a transmission period which can contain any combination of six information-bearing pulses. These pulses by their presence or absence, give a maximum of 64 possible codes which can be used to relay automatically height information.

To identify an aircraft, the pilot is requested by R/T to "ident": he then presses a button which causes a pulse to be radiated after the last framing pulse. This is obviously simpler and quicker than, for instance, the making of a temporary change of

course and is apparent immediately as a lengthening of the "paint" on the p.p.i. display.

An interesting feature of the equipment as installed at London Airport is the automatic monitoring of the performance of the ground transmitters and receiver by a transponder mounted some distance away. This is, of course, interrogated by the transmitters in the normal way. The selection circuits for side-lobe suppression are set to the extreme limit of the specification, so any deviation from correct performance of the ground equipment results in triggering on side lobes which shows up as responses from several bearings. A counter registers the number of interrogations in a given time and, assuming a known aerial rotation speed, this number is proportional to beam-width ( $2\frac{1}{2}^\circ$  with a 10% tolerance). Also an attenuator can be switched in to stimulate propagation attenuation of the extreme range.

## AUTOMATIC PRODUCTION LINE FOR RESISTORS

DESIGNED to manufacture deposited-carbon resistors, the Western Electric Company's production line at Winston-Salem, North Carolina, is almost completely automatic and incorporates a computer-controlled statistical quality-control. The process consists of eleven operations, each being programmed by the computer, which sets the line to manufacture resistors in four power-ratings and a vast number of resistance values. The computer also accepts feedback information from three points in the line, compares this with requirements and initiates corrections. The output of the computer is binary or binary-coded decimal, depending on the operation in question.

The first operation is the deposition on a ceramic rod of crystalline carbon obtained from methane decomposing at high temperature. As the coated rod leaves the coating machine, a Kelvin bridge provides the computer with an input proportional to the resistance of the coating. This analogue of voltage is digitized, stored on a magnetic drum and compared against a stored programme. Any difference output is used to control the speed of the core through the machine, the flow of gas and the temperature.

The next process is the application of a sputtered gold contact to each end of the core. Each core is fitted with a mask to protect the coating, the size of mask being chosen from four by programmed instructions from the computer. The core is now placed in a bell jar which is first evacuated and then filled with argon at low pressure. Sputtering takes place, giving a coating 0.00001-in thick.

End caps are now applied, the attachment of wire leads to the caps being the only operation performed outside the production line. The cap is applied with sufficient force to weld the gold-plated cap to the sputtered ends of the core. The computer selects cap sizes.

The helical groove giving a precise value of resistance is cut by rotating the resistor against a diamond-impregnated wheel. A wheatstone bridge, pre-set by the computer, disengages the wheel when the required value is reached and the bridge is balanced. Allowance for machine inertia and heat changes caused by the cutting process are stored in the computer. Helixing takes only three seconds.

The second inspection process now occurs. A computer-preset bridge measures the resistance, any off-balance being fed back to the computer, where it is digitized. Comparison between the fed-back and stored information is effected, and differences are used to adjust the setting of the helixing machine.

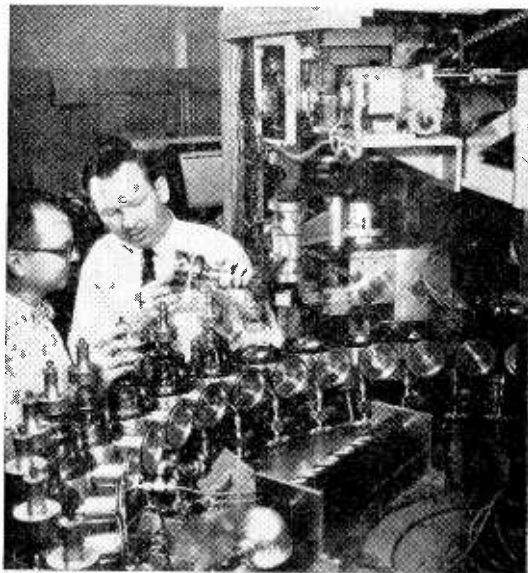

The 36-station gold sputtering machine, which applies a gold coating to the resistor ends. The gold cathode in one of the bell jars is being inspected. Loading of resistors into the machine is, in this as in all other processes, automatic.

The resistors are now encapsulated in epoxy resin. The pre-cured shell rests on the end-caps, leaving an air-space between the carbon and the shell, a feature said to prevent organic contamination of the carbon. Pellets of resin are formed over the ends and cured at 300° F.

After air-leak inspection—an underwater bubble test—the resistor is marked with its value by a computer-controlled offset printing machine.

A third inspection station operates a feedback loop to reset the second station, compensating for resistance changes caused by encapsulation heat.

Packing completes the process, which produces 1,200 resistors per hour, in any variety of power ratings and values, as programmed by the computer, which may be fed with sufficient instructions for a month's production.

# Soviet Exhibition in London

## RUSSIAN RADIO, TELEVISION AND ELECTRONICS ON SHOW

**E**NTERING the Soviet Exhibition at Earls Court was almost like stepping into another world: gone was the familiar ugly building, hidden behind yards of bunting and giant displays reaching almost to the roof. The exhibition was arranged in 23 halls which each exemplified achievement in a particular field, the central hall being devoted to space exploration. In the "Atom" hall models of many famous devices such as OGRA—a magnetic-mirror device for controlled thermo-nuclear fusion—were shown.

The introductory hall was concerned with science, and in it were shown many instruments for the measurement of physical and geo-physical phenomena and an example was equipment used for the frequency-analysis of seismic waves. A single cycle of seismic oscillation is photographed and presented repeatedly to the input, where it is mixed with the output of a variable-frequency heterodyne oscillator. The resulting frequencies are applied to a crystal filter during the open time of a gate; the output of the filter is detected and used to deflect a galvanometer, which records the amplitude of frequency components selected by the heterodyne oscillator on a pen recorder. The mechanism operating the paper feed also shifts the frequency of the oscillator and a complete spectrum is built up. Centre frequency is from 0.1c/s to 100kc/s.

What appeared to be a typical industrial batch counter—the PS100—was shown in its radiation monitoring application. The instrument is a low-frequency counter using one counting decade and four neon counting tubes.

An extremely comprehensive circuit-checker—the POOMA—will check the operation of circuit blocks requiring up to 3,000 connections. A punched-tape-programmed comparator samples the parameters of each circuit, compares them with the information in store and indicates the presence of a fault by coded lights. This method is 40 times faster than the normal procedures.

Electronic applications in industry and medicine were numerous: among the ultrasonic equipment was a "fountain" in which a liquid is excited strongly, the surface breaking up into a mist of droplets a few microns in diameter. This effect has been applied in medicine for the production of inhalant mists. Computer equipment shown included a Boolean function machine and some self-optimizing automation devices. A geophone and amplifier set, explosion proofed, for

gas-leakage detection and roof-fall warning in coal-mines had a companion tape recorder and encoding apparatus for feeding the signals over telephone lines. Also for coal-mine use was a dust-determining meter: this uses a radioactive isotope (thallium 204) as the source and works on the back-scatter principle.

Electronic measuring instruments were grouped, for some inscrutable reason, in the section devoted to the expression of "Public Well-Being." The performance claims of many of the instruments were modest by comparison with Western standards: it is possible that the more advanced equipment was not on show.

Two oscilloscopes of fairly advanced design were shown, the UO-1M—a single-beam instrument, and the DEO-1—a double-gun instrument with extensive facilities. The UO-1M has a frequency-response of 0-20Mc/s ( $-3\text{dB}$ ) and a sensitivity of 100mV/cm. The time-base speeds are from 25nsec/cm to 25msec/cm and rise-time is 20nsec. A selection of vertical amplifiers is available. The DEO-1 employs identical vertical amplifiers, with a bandwidth of 0-20Mc/s and a double-gun tube is used.

A low-frequency Q-meter, known as the IMI-3, covers the range 1kc/s to 100kc/s and will measure Q from 2 to 200 at an accuracy of  $\pm 6\%$ . Inductance measurements may be made in the range 0.1mH to 1H, with  $\pm 10\%$  accuracy. The frequency is indicated by

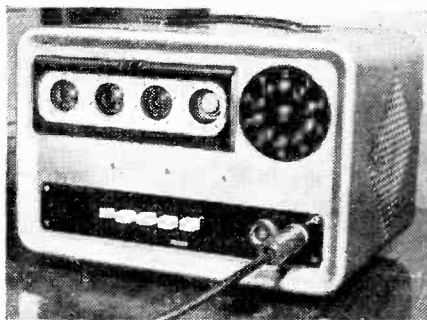

PS-100 batch counter employing counting decade and neon counting tubes.

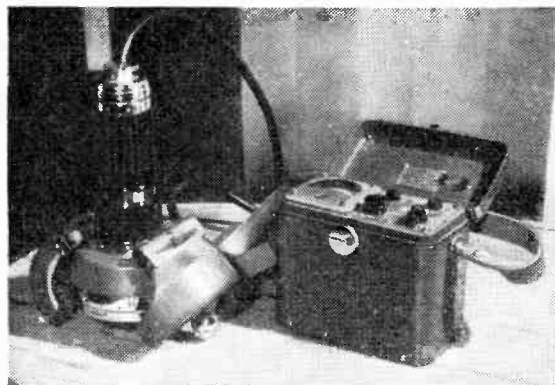

Back-scatter coal-dust monitor for use in mines.

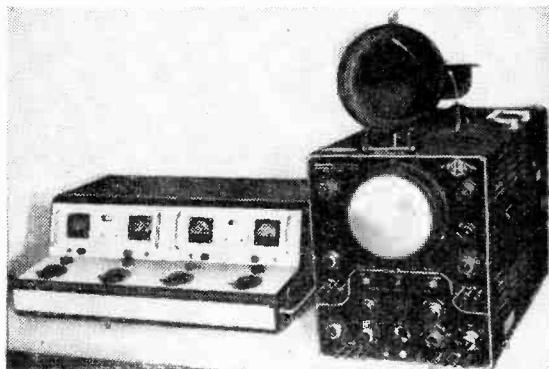

Four-channel electroencephalograph built by students of a vocational school at Omsk.



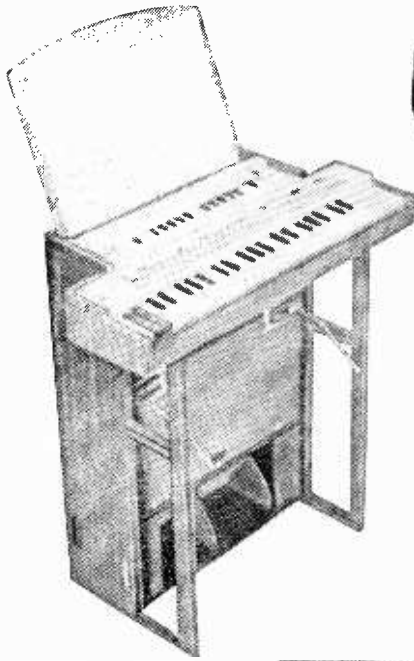

Electronic musical instrument, Ekvodin, uses valve tone generator.

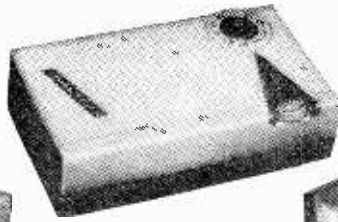

Above: "Mir" transistor portable receiver uses six transistors and produces 50mW at 20dB signal-to-noise in a field-strength of 5 $\mu$ V/m.

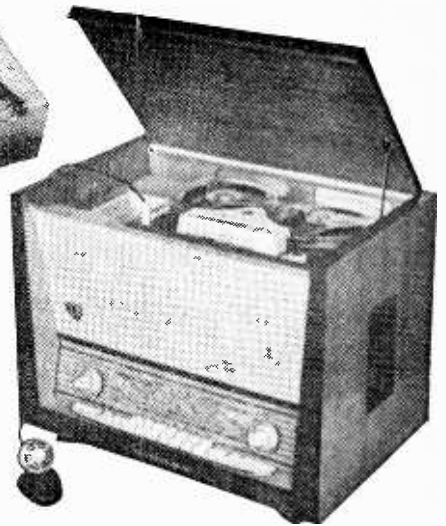

Right: "Neringa" Magnitola consists of a.m./f.m. radio with 7.5 in/sec twin-track tape recorder.

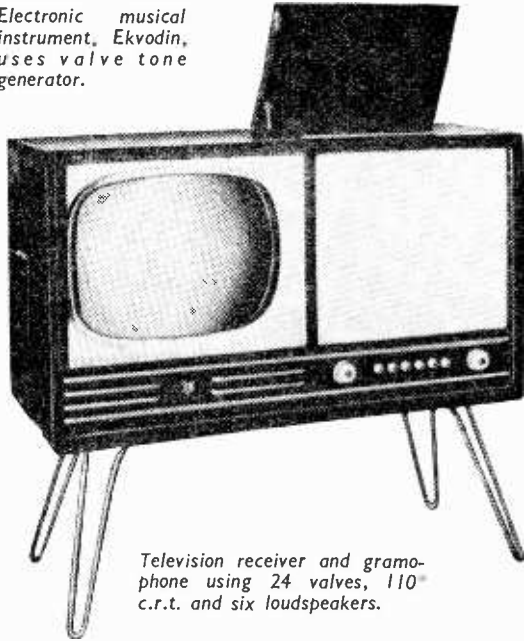

Television receiver and gramophone using 24 valves, 110° c.r.t. and six loudspeakers.

an in-line digital system. A range of slotted-lines working in the range 2,600Mc/s to 8,300Mc/s was shown. The frequency-range is covered by five separate instruments and the accuracy of measurement is  $\pm 4\%$ .

Domestic apparatus was, more understandably, also shown in this section. The television receivers cover a wide price range, from about 160 roubles\* for the cheapest 17-in set, up to about 750 for a colour receiver using a shadow-mask tube. These latter have not yet reached quantity production and are only intended for communal viewing in clubs or "palaces of culture". The Russians are making their own shadow-mask tubes and they use an adaptation of the N.T.S.C. standard.

For black-and-white TV both 110° and 70° c.r.t.s are in use, as are frame-grid valves which are sometimes

\* 2.5 roubles  $\approx$  £1 sterling

employed for the video amplifier. Vision a.g.c. and timebase stabilization are common in the newer sets and some employ ingenious means for f.m. broadcast reception: for instance, the "Rubin 104" and "Almaz 105" have a second frequency changer to convert the 8.4Mc/s f.m. i.f. to the 6.5Mc/s sound i.f. so that the set's intercarrier circuits can be used. Headphone and tape-recorder outlets are often fitted and semiconductor rectifiers are used widely. A notable feature was the use of a 4:3 aspect ratio, even for the 110° tubes.

Combination sets are popular—sometimes a radio tuning medium and long waves as well as a turntable and pickup is incorporated with the television and f.m. receiver all in one small table-model box.

A transistor TV receiver (the Moskva) was on show—this was housed in a leather case and used a c.r.t. of about 8-in diagonal. Nickel-iron cells (12V) are used for power supply and the price is about 250 roubles.

Radio receiver production follows closely the "Continental" pattern with bandsread s.w. ranges, high sensitivity and selectivity and multiple loudspeaker systems in all but the cheapest and smallest models. Like the television receivers, several printed-circuit panels are often used and the whole is very strongly constructed.

Combinations are popular here, too. A less usual grouping seen included a tape recorder under the top lid ("Neringa" Magnitola) and some models also embody a turntable and pickup with provision for disk-copying. Tape speeds in common use are 7½ and 3¼ in/sec with two-track recording and a transistor model was shown.

Demonstrations of CTEPEO (stereo) recordings were given in the "Hall of Sterophonic Sound," and some of the radiogramophones shown had provision for the playing of stereo disks. Stereo broadcasting, too, is being tested, using polarity modulation in which alternate half-cycles of the carrier are amplitude modulated with the two channels. For radio transmission this carrier forms a 30kc/s subcarrier to an f.m. carrier.

The Ekvodin—an electronic musical instrument—is available in two versions, mono- and di-phonic. Keyboard played, these provide many timbres, imitating most orchestral and folk instruments.

In the field of electromedical equipment, the Luch apparatus, which is an automatic reading-machine for blind people, was probably the most interesting. This device works on the light-reflection principle, the differing areas of black in each letter reflecting a different amount of light on to a photoelectric device, when scanned by a narrow beam of light. The varying output of the light-sensitive device is decoded, each level corresponding to a letter. The sound of this letter is generated electronically and fed to a speaker.

# Problems in Standardization

WITH PARTICULAR REFERENCE TO

SPECIFICATIONS FOR MAINS SWITCHES

By M. G. B. MASON

**I**T is interesting to investigate the history of long-established components employed in electronics circuits and to discover the changes in design and specification made necessary by modern techniques. The manufacturer of these components usually has two methods of ensuring the adequacy of his product. First, by environmental testing in collaboration with the equipment manufacturer; where equipments and circuits likely to place different demands on the component are used. Secondly, by testing in the way laid down in the appropriate specifications, and meeting the limits. Test standards and specifications are developed, published and adopted as a result of liaison between the various representative associations of the electronics industry, nationally and internationally.

Ideally, the two methods should be complementary as a test standard agreed by the industry at large cannot always anticipate the very sudden changes and advancements of circuit techniques. In general it may be said that for "earth-bound" equipment at least climatic test conditions in terms of temperature and humidity, now a feature of all these test standards, are not subject to frequent change.

## Potentiometers with Switch

This article is concerned with commercial, as distinct from Services, standards, and takes as an example the experience of a manufacturer of potentiometers incorporating a mains switch. This form of switch has been used in domestic radio and television receivers for a considerable number of years and, although it has from time to time become harnessed to wave-change switches, tuners, separate knobs and push-buttons at the dictates of styling, it is invariably the same basic switch.

Safety and reliability of the mains switch are vital, and in this country British Standards Specification 415 "Safety Requirements for Radio and

other Electronic Apparatus" prescribes minimum creepage distances in relation to working voltage and current ratings as well as test proof voltages. These conditions must apply equally to all parts of the equipment where may be found mains potentials and metal conductors likely to be accessible to the user. Primarily, therefore, the mains switch must be designed so as to meet these requirements. For the purpose of environmental testing, the Radio Industries Council, in consultation with component manufacturers, produced and published Specification R.I.C.122 some years ago. This, in addition to prescribing tests and climatic gradings for the potentiometer itself, included test load conditions for cyclic endurance of the switch, calculated to

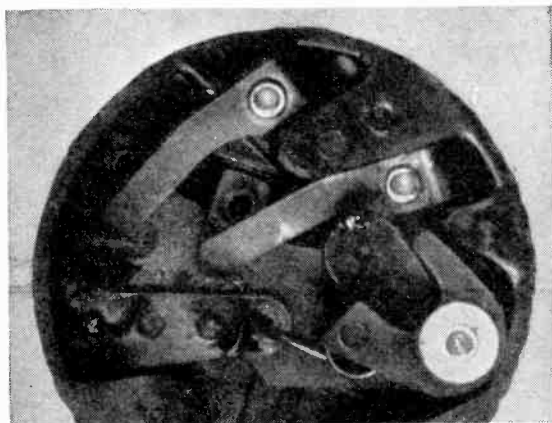

*Obsolete pattern of switch showing arcing and contact burning after a few hundred cycles at 2 amps, power factor 0.6.*

represent ten years of normal usage. This specification provides the basis for tests to evaluate the suitability of potentiometers for use in equipments, whether in this country or for export, according to their climatic grading. A forthcoming British Standard equivalent in function to this specification is intended, which will be our national standard.

## National and International Standards

Many countries have their own national test standards and committees comprised of delegates from each country's representative national-standards committees meet regularly to formulate international standards, based on the International Electrotechnical Commission in Geneva. The standards thus produced show much evidence of the acceptance of parts of various national test standards; but clearly

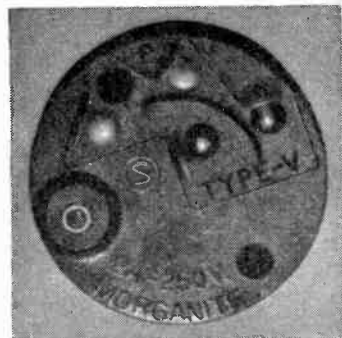

*The "S" mark (near centre). Only switches which bear this mark may be sold in Sweden.*

the ideal objective is a common test standard for each component. For switches employed in domestic and other mains-operated equipment the Commission on Rules for the Approval of Electrical Equipment have produced Publication C.E.E.14, "Specification for switches for Domestic and Similar Purposes."

The application of national standards varies from country to country and only a few governments make them mandatory when concerned with other than Services requirements.

The exceptions are notably the Scandinavian countries and where safety, for instance, is concerned, approval for use in equipments is granted only after arbitrary tests carried out by their government test houses. These standards are very similar to the requirements of C.E.E.14 in detail.

The Swedish government's test organization ("SEMKO") carries out tests on production samples submitted to them. If every sample passes these tests, the switch manufacturer is permitted to mark his product with the special "S" mark. The manufacturer's adherence to the required standard is checked by demanding further test samples from time to time.

Equipment manufacturers must use mains switches so marked and approved before they are permitted to sell in Sweden. Denmark, Norway and Finland adopt similar practices, but will usually accept the "SEMKO" mark, if applicable, in lieu of their own test approval.

The "SEMKO" test is most stringent: it does not countenance a single failure or momentary hesitation in 20,000 operations on full rated load at a power factor  $\cos \phi = 0.6$ . An automatic monitoring system is employed to detect faults. Other tests in the "SEMKO" specifications include overload, temperature rises of contacts, resistance to heat, fire, tracking, and humidity environmental tests. Approval will not be granted if a single specimen fails any test.

Switches designed for attachment to potentiometers are tested by "SEMKO" as a complete assembly. Hence it is necessary not only to ensure satisfactory performance of the switch; but also to ensure that the entire assembly and method of operating the switch are reliable.

### Specific Problems

To enable a switch to meet the "SEMKO" requirements, the following attention was required to an otherwise fully acceptable and reliable article. The switch was rated to break 2A at 250V and the two most difficult requirements were the full loading at 0.6 power factor and 20,000 operations at this loading without a single falter by any test specimen.

Comparing contact burning under load conditions (0.8 power factor) as required by our own domestic specification with those required by "SEMKO," it was found that 2A at 0.6 power factor was equal to 6A at 0.8 power factor, at like voltage. Tracking problems were rendered complex by the fact that for 10,000 operations one pole was at line potential and the metal work of the potentiometer at neutral and, for the second 10,000 operations, the other pole took the line voltage and load.

Therefore tracking paths had to be increased by the moulding of baulks, and the use of non-tracking grades of moulding powder was, of course, essential.

Choice of contact lubricant was found to be critical and the lubricant had to be non-carbonising.

Friction between moving parts had to be controlled carefully both in production as piece parts and during assembly; the operating spring had to be consistent in manufacture, both in dimensions and in tensile performance.

The resultant article was then "quality controlled" by sampling, and to pass 20,000 operations under these conditions meant that at least 50,000 operations had to be achieved before mechanical breakdown.

### Conclusions

The achievement of "SEMKO" approval is costly and far from easy. Its attainment means that the article concerned is tested to a very high degree of safety and reliability.

It is interesting to reflect that if the switch in a radio or television receiver carries one of the

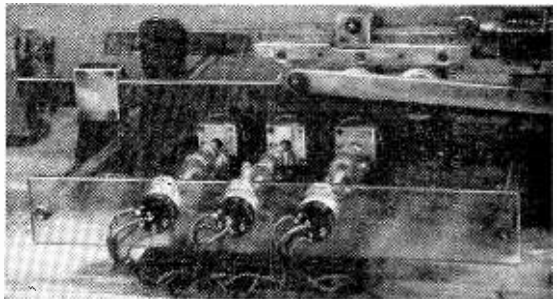

Equipment for endurance testing of switches (above). Resistive parts of loads (below) are electric fire elements, inductive parts are special chokes of Swedish manufacture identical with those used in the "SEMKO" laboratories.

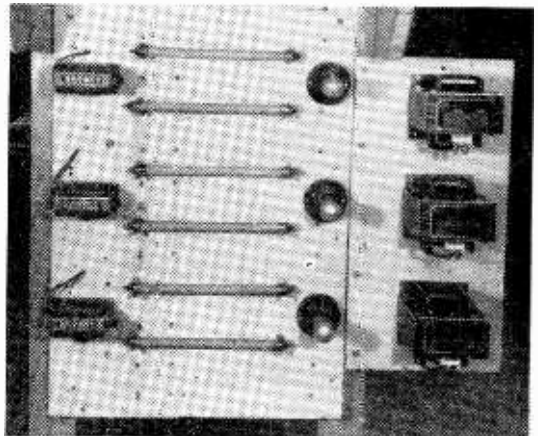

Scandinavian approval marks, it is not only smaller in physical size; but is tested to a higher standard than is often appropriate to a switch used in bathroom and kitchen, where the consequences of failure are liable to be much more serious.

The author is indebted to the Directors of Morganite Resistors Limited for permission to publish this work.

# WORLD OF WIRELESS

## *European V.H.F./U.H.F. Broadcasting*

WHAT is believed to be the first international broadcasting conference since the war at which all accredited delegations signed the agreement ended in Stockholm a few weeks ago. The plans, covering frequency allocations in Bands I, II, III, IV and V have been approved in draft form and will in due course be issued by the International Telecommunications Union. Until the "Final Acts" of the Conference are available we must confine ourselves to unofficial reports.

The plans for the v.h.f. bands include only stations with an e.r.p. of 1 kW or more and in the u.h.f. bands only those of 10 kW or more. Requests for frequencies for lower-powered stations are being collated by the International Frequency Registration Board who will send a list to all European administrations for comment preparatory to approval.

So far as the U.K. is concerned we understand we have retained our existing assignments in Band I and there has been some easing of the power restrictions in the direction of the Continent, laid down in the 1952 Stockholm Plan.

At present we do not utilize for sound broadcasting the whole of Band II, the upper 5 Mc/s being used for other services. However, our delegation secured assignments in this section of the band so that the v.h.f. sound broadcasting service could be extended if desired.

Our position in Band III is unchanged although provision has been made for many stations to increase their power.

Until this conference there had been no allocations in Bands IV and V, although, of course, a number of stations were already in operation in West Germany. All European administrations have agreed to 8-Mc/s channel spacing in these bands. The maximum is fourteen channels in Band IV (470-582 Mc/s), but considerably fewer than the maximum number of 47 channels in Band V (610-960 Mc/s) have been assigned to television stations. The frequency band 860-960 Mc/s will, it appears, be used largely for fixed services, including, in accordance with the Geneva Radio Regulations, tropospheric scatter links. However, our application for sufficient channels in these bands for four programmes, each with almost national coverage, was granted.

## *Berlin Radio Show*

THIS year from August 25th to September 3rd the German Radio Exhibition returns once again to Berlin after a series of biennial shows in Düsseldorf and Frankfurt-am-Main. The Berlin exhibition grounds, including the summer garden, surrounding the Funkturm have an area of 25 acres of which no less than 16 acres is under cover. The big firms have each taken separate pavilions and special television shows will be staged in the Deutschland-Hall. The B.B.C. have taken a pavilion to mount an exhibition on the theme "B.B.C. Greets Berlin."

Visitors are expected from all parts of Germany and from abroad and the railways and air lines will supplement the normal services to and from Berlin. The organizers expect a total attendance of the order of 750,000 (compared with 532,000 in 1959, and 493,000 in 1957).

## *Earls Court Radio Show*

THE 28th National Radio and Television Show opens at Earls Court, London, on August 23rd until September 2nd (excluding Sunday, 27th). At this show the B.B.C. and the industry will be celebrating the 25th anniversary of the British television service which was introduced at the 1936 exhibition. To mark the occasion the B.B.C. is staging a demonstration of colour television. In addition to some 70 manufacturers, many user organizations have taken space and in all there will be nearly 100 exhibitors. Our next issue will include a plan and pre-view of the show.

**The Paul Instrument Fund Committee**, set up in 1945 "to receive applications from British subjects who are research workers in Great Britain for grants for the design, construction and maintenance of novel, unusual or much improved types of physical instruments and apparatus for investigations in pure or applied physical science," has awarded £3,900 to Dr. P. B. Hirsch, lecturer in physics, University of Cambridge, for the construction of an electron optical instrument which will measure the energy distribution of the electron beam passing through small areas (diameter less than  $1\mu$ ) in the crystal specimen which can be observed and selected on the electron microscope image. The Committee has also awarded £3,000, supplementing a previous grant, to Dr. H. Motz, Donald Pollock Reader in engineering sciences, University of Oxford, for the construction of a linear accelerator working at 1.6cm (J-band).

**1963 Computer Conference.**—The second congress of the International Federation of Automatic Control (I.F.A.C.) will be held in Basle, Switzerland, in September 1963. Papers will deal with the theory or application of automatic control and the components of control devices. Offers of papers from this country should be made to the British Conference on Automation and Computation, c/o The I.E.E., Savoy Place, London, W.C.2. General inquiries concerning the congress should be made to the secretary of I.F.A.C., Dr.-Ing. G. Ruppel, Prinz-Georg-Strasse 79, Düsseldorf, Germany.

**Science and Parliament.**—The Marquess of Salisbury is the new president of the Parliamentary and Scientific Committee which this year celebrates its coming of age. This is an unofficial non-party group of nearly 200 members of both Houses of Parliament and representatives of over 100 scientific and technical organizations. The Committee sponsored the first European Parliamentary and Scientific Conference, held in London in March, which was attended by representatives from 17 European countries.

**Colour TV Book.**—As we go to press we learn from our publishers that the long-awaited book "Colour Television," by P. S. Carnt and G. B. Townsend, will be available at the end of July. The 478-page book, which costs 85s, describes the N.T.S.C. system with particular reference to 405 lines, but wherever there are differences between the 405, 525 and 625-line systems these are fully explained.

**I.E.E. Council.**—Officers and ordinary members elected to fill the vacancies on the I.E.E. Council which will occur on September 30th are:— President, G. S. C. Lucas (A.E.I., Rugby); vice-presidents, A. H. Mumford (G.P.O.) and Dr. R. L. Smith-Rose; treasurer, C. E. Strong (S.T.C.); ordinary members, Dr. J. Brown, (University College, London), Sir Robert Cockburn (Ministry of Aviation), Dr. J. S. McPetrie (Ministry of Aviation), G. Millington (Marconi's), Prof. C. W. Oatley (Cambridge University), P. L. Taylor (A.E.I., Manchester) and H. West (A.E.I., Manchester).

**I.E.E. Electronics Committee.**—The following have been elected to fill the vacancies occurring on September 30th on the committee of the Electronics and Communications Section of the I.E.E.:— Chairman, R. J. Halsey (G.P.O.); vice-chairman, J. A. Ratcliffe (D.S.I.R.); ordinary members, V. J. Cooper (Marconi's), H. Davies (B.B.C.), G. W. A. Dummer (R.R.E.), Dr. R. Feinberg (Manchester College of Technology), C. A. Marshall (*British Communications & Electronics*) and Dr. R. C. G. Williams (Philips).

**B.S.R.A.**—The proposal to change the name of the British Sound Recording Association to that of the British Audio Society was discussed at the recent annual general meeting but no change is being made. The re-elected officers include P. J. Walker (president), S. W. Stevens-Stratten (secretary), and R. L. West (technical secretary). The elected council members are R. J. Barton, P. M. Clifford, Hon. J. Dawnay, J. W. Maunder, J. Moir and E. B. Pinniger. To mark the Association's silver jubilee a convention is to be held at the I.E.E., Savoy Place, London, W.C.2, on October 13th, 14th and 15th.

**E.C.M.A.** are the initials of the recently formed European Computer Manufacturers' Association which has its headquarters in Geneva. The first president of the Association is C. G. Holland-Martin, Research Director of International Computers and Tabulators Ltd. Other U.K. manufacturer-members are:— A.E.I., E.M.I., Elliott Brothers, English Electric, Ferranti and Leo Computers. Four technical working committees are being set up to cover (a) Codes representing characters for use in computer "input" and "output," (b) Common programming languages, (c) Diagrammatic and symbolic representation of processes and (d) Character recognition.

**B.R.E.M.A. Vice-Chairman.**—E. P. Wethey (Kolster-Brandes) has been elected vice-chairman of the British Radio Equipment Manufacturers' Association in succession to W. M. York (E. K. Cole). A. L. Sutherland (Philips Electrical) remains chairman.

**International Television Convention.**—The "technological aspects of the whole television field" will be covered during the International Television Convention being organized by the Electronics and Communications Section of the I.E.E. for next year. It will be held at the I.E.E. headquarters in London from May 31st to June 7th. The chairman of the organizing committee is Dr. R. C. G. Williams of Philips.

**Photomultipliers.**—A symposium on photomultiplier tube applications is being organized by E.M.I. Electronics for September 13th to 15th. It will be held at E.M.I. House, Manchester Square, London, W.1, and a fee of 5gn will be charged. Applications for registration forms should be sent to E.M.I. Electronics, Ltd., Valve Division, Hayes, Middlesex.

**Radio Components Show.**—We regret that on p. 364 of the July issue a photograph of Sydney S. Bird's (Cyldon) Type PC80 transistor push-button television tuner was inadvertently ascribed to A. B. Metal Products. We apologize to both companies for this error.

**Colour TV.**—The Television Society is organizing a refresher course of six lectures on colour television which will be held on the six consecutive Monday evenings from September 18th at the London School of Hygiene and Tropical Medicine, Keppel Street, London, W.C.1. The course will cover a description of the N.T.S.C. system, transmission and receiver problems and the lecturers will be S. N. Watson (B.B.C.) and G. B. Townsend and P. Carnit (G.E.C.). Enrolment forms are obtainable from the Television Society, 166 Shaftesbury Avenue, London, W.C.2, the fee for non-members being two guineas.

**Physics of semiconductors,** rather than their applications, will be the theme of an international conference to be held at the University of Exeter from July 16th to 20th next year. It is being arranged by the Institute of Physics & Physical Society under the auspices of the International Union of Pure and Applied Physics and the British National Committee for Physics. Dr. R. A. Smith, of the Royal Radar Establishment who in September goes to the University of Sheffield as Professor of Physics, is chairman of the organizing committee. Details of the conference, attendance at which will be limited to 400, are obtainable from the organizers at 47 Belgrave Square, London, S.W.1.

**Next year's I.E.A. Exhibition.**—Applications from a record number of over 400 manufacturers, including many from abroad, have been received for participation in the fourth International Instruments, Electronics and Automation Exhibition which will be held at Olympia, London, from May 28th-June 2nd, 1962. The organizers are Industrial Exhibitions Ltd., 9 Argyll Street, London, W.1.

**Paris Components Show, 1962.**—Next year's International Components Show, organized by the Fédération Nationale des Industries Electroniques, will be held in Paris from February 16th-20th.

**Noise Measurement.**—A five-day course on the measurement of noise begins at the Royal College of Advanced Technology, Salford, on September 11th. Details of the course are obtainable from Dr. Peter Lord, at the College.

**Network Theory.**—A symposium on network theory will be held at the College of Aeronautics, Cranfield, Bucks., from September 18th-22nd, details of which are obtainable from S. R. Deards of the College's Department of Aircraft Electrical Engineering.

**Cardiological Apparatus.**—The annual exhibition organized by the Society of Cardiological Technicians of Great Britain will be held at the Londoner Hotel, Welbeck Street, London, W.1, on October 27th (5.30-9.0 p.m.) and October 28th (9.30 a.m.-1 p.m.).

**The new address** of the National Council for Technological Awards is 24 Park Crescent, London, W.1. (Tel.: LANgham 4879).

## CLUB NEWS

**North Kent Radio Society** is again operating a station (GB3ENT) at the Borough of Erith's annual show at the Erith Recreation Ground on August 7th.

**Stamford Radio Club** is holding its first rally on August 27th at Burghley Park, near Stamford, Lincs.

**Luton and District Radio Society** is organizing a mobile rally on August 20th at Stockwood Park, Luton, Beds. The talk-in stations (from 10.30 a.m.) will be G3CGQ/A and G3JZW/A on 2 and 160 metres.

**Silverthorn Radio Club** will be operating a field station (GB3SRC) on the borders of Epping Forest from the evening of August 4th until the evening of the 7th. It will operate on 160 metres.

# Personalities

**G. Darnley-Smith, C.B.E.**, is retiring at the end of September from the managing directorship of Bush Radio Ltd., which he has held since the formation of the company in 1932, but he will remain on the board. He will be succeeded by **Dudley Saward** who has been managing director designate since February. Mr. Darnley-Smith relinquished the managing directorship of Rank Cintel Ltd., on June 30th and is succeeded by **J. C. G. Bell**, managing director designate since January. Notes on the appointments of both Mr. Saward and Mr. Bell appeared in our March issue (p. 118). Mr. Darnley-Smith is retaining the position of joint deputy chairman of the associated company Bush and Rank Cintel Ltd. He has been chairman of the Radio Industry Council's Television Reception Policy Committee since its formation in 1948 and is one of the two representatives of the R.I.C. on the Government's Television Advisory Committee.



G. Darnley-Smith



G. A. Smith

**George A. Smith**, who joined the Plessey Company in 1957, has been appointed general manager of the company's Electronic and Equipment Group of which he has been commercial executive for the past year. He spent the war years as a radar officer in 60 Group of the R.A.F. and was for 10 years with Pye, initially as a development engineer and later as export manager of the Pye Telecommunications Division.

**Air Cdre. C. M. Stewart, C.B.E.**, has succeeded **A.V.-M. G. C. Eveleigh, O.B.E.**, as Director General of Signals at the Air Ministry, with the acting rank of Air Vice-Marshal. Since 1958 he has been chief electronics officer at Fighter Command. From 1955 to 1957 he was chairman of the Communications Electronics Committee of the N.A.T.O. Standing Group, Washington, and was subsequently Air Officer Commanding No. 27 Group Technical Training Command, R.A.F. A.V.-M. Eveleigh has become Air Officer, Administration, at Fighter Command.

**R. J. Bailey** has been appointed vice-president of The English Electric Corporation in New York, which was recently formed to co-ordinate the American activities of the English Electric Group. Mr. Bailey joined Marconi Instruments in 1938 and served in the Royal Navy during the War attaining the rank of Lieut. Commander as Radar Officer of H.M.S. *Formidable*. In 1946 he rejoined Marconi Instruments and was manager of their London office before going to America in 1954 as U.S. manager of Marconi Instruments which is, of course, a member of the English Electric Group.

**Olliver W. Humphreys, C.B.E., B.Sc., F.Inst.P., M.I.E.E.**, technical director of the G.E.C. and director of the Hirst Research Centre, Wembley, has been appointed chairman of the new company, International Systems Control Ltd., which, as announced elsewhere, has been formed jointly by the G.E.C. and Thompson Ramo Wooldridge Inc., of Los Angeles. Mr. Humphreys, who is 58, joined the G.E.C. Research Laboratories (now the Hirst Research Centre) in 1925 and has been director for the past 10 years.

**David N. Truscott, O.B.E., A.C.G.I., D.I.C., B.Sc., Ph.D., Sc.D., M.I.E.E.**, has been released by the G.E.C. from his position as general manager of its Electronics Division to become managing director of the new company, International Systems Control Ltd. Before joining the G.E.C. in 1951 Dr. Truscott had been in Government service for 12 years and from 1935 to 1939 was in the engineering department of Murphy Radio. He studied communications engineering at Imperial College, London, and then went to the Massachusetts Institute of Technology where he undertook research in communications and in 1935 received his Sc.D. degree. **Dr. Eugene M. Grabbe**, vice-president and a director of Compagnie Européenne d'Automatisme Electronique, an associate company of Thompson Ramo Wooldridge, has been appointed deputy managing director of I.S.C. The non-executive members of the board of I.S.C. are **G. W. Fenimore** and **M. E. Mohr** of T.R.W., and **W. A. C. Maskell, B.Sc.**, managing director of the G.E.C. Telecommunications Group, who has been with the company since 1925.

**Eliot E. Dweck, L-e-S., A.M.I.E.E.**, recently joined the Westrex Co., as head of the Projects Division. He was at one time a departmental head in the Nelson engineering laboratories of English Electric Company and more recently has been engaged on special investigations into advanced problems of radar and computing equipment for Decca Radar. It is also announced by Westrex that **Commander F. Holmes** has been appointed a director with responsibility for sales.



E. E. Dweck



H. C. Briggs

**H. C. Briggs**, the new vice-president of Collins Radio International, is also the company's European manager, and as such has administrative responsibility for Collins Radio Company of England Ltd, and other European subsidiaries. Before joining Collins, with whom he has been Director of Government Relations in Washington for some time, he was vice-president of Hoffman Laboratories. His headquarters are in London.

**G. S. C. Lucas**, O.B.E., F.C.G.I., president of the I.E.E. for 1961/62, is a director and chief engineer of A.E.I. (Rugby), and a director of A.E.I. Sound Equipment. He joined the B.T.H. research laboratories in 1925 and was head of the electrical and development section from 1932 until 1944 when he became head of the electronics engineering department. He has been chief engineer of B.T.H. (now A.E.I. Rugby) since 1953. He received the Fellowship of the City and Guilds of London Institute in 1959 "for radar and electronic research and services in technical education."



G. S. C. Lucas



R. J. Halsey

**R. J. Halsey**, C.M.G., B.Sc.(Eng.), F.C.G.I., D.I.C., chairman of the Electronics and Communications Section of the I.E.E., is Director of Research in the Post Office and also a director of Cable & Wireless Ltd. He is well known for his work on the planning and engineering of the first transatlantic telephone cable and since 1959 has been controller of the joint G.P.O./C.&W. submarine cable and repeater development unit. He entered the engineering department of the Post Office in 1927 at the age of 25.

**Frank Poperwell**, Assoc. Brit. I. R. E., has joined the Derritron group of companies as group technical sales supervisor. He had been with the G.E.C. for 35 years. In 1945 he was appointed engineer-in-charge of the G.E.C. Radio Department's Sound Equipment Section and last year he became technical supervisor of the Sound Equipment Division. He is a vice-president and vice-chairman of the Association of Public Address Engineers.



F. Poperwell

**G. D. Monteath**, B.Sc., A.R.C.S., A.Inst.P., A.M.I.E.E., D.I.C., who joined the B.B.C. in 1947 as a research engineer, has been appointed head of the Television Group of the Research Department in succession to **Dr. R. D. A. Maurice** who recently became assistant head of the Department. Mr. Monteath was for five years in charge of the aerial section of the Research Department.

**A. J. Henk**, who contributes the article on page 425, is senior engineer (maintenance) with Alpha Television Services (Birmingham) Ltd. who operate the Midlands Independent Television Studio Centre for A.T.V. and A.B.C. Television. For 18 months prior to going to the Midlands in 1956 he was with the B.B.C.

**J. W. Murray**, M.B.E., Assoc.I.E.E., A.M.Brit.I.R.E., has relinquished his post as chief engineer of the Nigerian Broadcasting Corporation and is succeeded by **E. Credgington**. Mr. Murray went to Nigeria as chief engineer of the Department of Broadcasting in January, 1951, after serving in a similar capacity for four years in Northern Rhodesia. Prior to going to Rhodesia he was with the B.B.C. for seven years. Mr. Credgington has been assistant chief engineer (operations and maintenance) with the Nigerian Broadcasting Corporation since October 1957, prior to which he was in Malaya's Department of Broadcasting for 12 years. He was seconded from the B.B.C. to Malaya in 1945.

**W. H. Taylor**, B.Sc.(Eng.), M.I.E.E., education officer to the I.E.E. from 1947 until 1953 when he joined the G.E.C. as Controller, Education and Personnel Services, has been appointed Manager, Group Personnel Services of A.E.I. (Rugby).

## OBITUARY

**Dr. Lee de Forest** died in California on June 30th, aged 87. He will be mainly remembered as the inventor of the "audion" valve (1906) which added a control grid to the Fleming diode, but this was by no means his only contribution to the early development of wireless. After long litigation he was finally awarded priority for the discovery of "feedback" and the oscillating valve and he was active earlier in the fields of spark and arc generation and later developed the "Phonofilm" a method of synchronizing sound with cinematograph film.

**H. V. Griffiths**, M.B.E., who had been engineer-in-charge of the B.B.C.'s Measurement and Receiving Station at Tatsfield since 1933, died on June 28th at the age of 59. He joined the B.B.C. in 1924 as an assistant maintenance engineer at the Birmingham transmitting station (5IT). He was engineer-in-charge of the experimental short-wave "Empire" station (G5SW) at Chelmsford for a short time before transferring to the Research Department in 1928. He was widely known as an authority on radio propagation and frequency measurement on which subjects he has contributed to *Wireless World*.

**Leslie E. C. Hughes**, Ph.D., B.Sc.(Eng.), M.I.E.E., who died suddenly on June 10th at the age of 57, was the first president of the British Sound Recording Association, 1946-8. His teaching career began in 1927 at the City and Guilds College, where he was a demonstrator. From 1932 to 1941 he was lecturer and degree-examiner at the College, and for 3 years from 1936 was evening lecturer at Regent Street Polytechnic and Northampton Polytechnic, London. Dr. Hughes was for a time with Multitone Electric Co. on hearing aid design and from 1943 to 1947 was head of the Research Dept., Broadcast Relay Service at their Wandsworth factory. In 1955 he became Head of Technical Publications for Ultra Electric.

**Phillip D. Canning**, the well known representative of the Plessey Company on many national and international councils and committees, died in Basle on July 1st whilst returning from a conference of the International Electrotechnical Commission in Interlaken. He was chairman of the sub-committee of the I.E.C. which deals with climatic and durability testing of telecom. He joined Plessey in 1933 and was for some years responsible for the development and production of transmitting equipment and for radio installation work. Since 1948 he had been acting as liaison between the company and trade associations.

**Stanley G. Wilby**, at one time editor of *Wireless & Electrical Trader* and for some years until 1959 head of the press and public relations section of the British Standards Institution, died on June 23rd aged 60. He had been in failing health for several years.

# News from Industry

**Bristol/Ferranti Bloodhound.**—The Royal Swedish Air Force Board has placed a substantial order running into many million pounds with Bristol Aircraft Limited for the Bloodhound Mark 2 surface-to-air guided weapon system which is to be supplied to the R.A.F. Dr. Norman Searby, C.B.E., manager of Ferranti's Guided Weapons Establishment, has said that the most important single factor in the improvements in performance compared with the earlier version is the use of continuous-wave radar guidance, developed in conjunction with the Ministry of Aviation by Associated Electrical Industries and Ferranti. Sweden became the first overseas country to adopt a British guided weapon for defence purposes when she placed an order for Bloodhound I in 1958. The new contract is the largest overseas order yet placed for British missiles.

**International Systems Control Ltd.** has been formed jointly by the G.E.C. and Thompson Ramo Wooldridge Inc., of Los Angeles, with a share capital of £430,000 equally shared by the two parent companies. It will market industrial process control systems in the U.K., the European Free Trade Area and the Commonwealth. It is announced that this "venture is complementary to and in no way clashes with" the G.E.C.'s present association with International Computers and Tabulators Ltd. in the development and manufacture of digital computers. Details of the board of the new company, which will have its headquarters in London, are given on page 404.

**Thorn-A.E.I. Tube and Valve Merger.**—Thorn Electrical Industries and Associated Electrical Industries are merging their respective interests in the manufacture and sale of cathode-ray tubes and radio valves. Trade names involved include Mazda, Ediswan and Brimar. The productive capacity of both companies in this field, including factories at Sunderland, Harlow, Rochester and Footscray, will be pooled. Management of the new joint company will be vested in Thorn Electrical Industries with Jules Thorn as chairman.

**Multimusic Ltd.**, a wholly-owned subsidiary of Multicore Solders Ltd., has disposed of all its interests in Reflectograph tape recorders to Pamphonic Reproducers Ltd., a member of the Pye Group. Service enquiries should be addressed to Pamphonic Reproducers Ltd., Westmoreland Road, Queensbury, London, N.W.9 (Tel: Colindale 7131). Other enquiries concerning Reflectograph recorders should now be sent to Pamphonic at 17 Stratton Street, London, W.1 (Tel.: Grosvenor 1926).

**G.E.C.'s Applied Electronics Laboratories** at Stanmore, Middlesex, have been entrusted with the development of the guidance receiver for the Mark 2 Seaslug ship-to-air missile, the existence of which was made known in the recent Navy Estimates. Four County Class destroyers are about to start their operational careers with Seaslug 1 for which the G.E.C. was responsible for the development of the guidance receiver.

**India's first transistor manufacturing company**—Semi-conductors Private Ltd.—has been established in Poona. Raytheon Company, of Lexington, Mass., owns a one-third interest.

**Iraqi Ports Authority** has placed a £100,000 contract with Pye for the supply and installation of a v.h.f. and u.h.f. radio-telephone network for the country's marine and air ports.

**British Railways' first multi-channel radio-telephone system** is to be installed between York and Newcastle via Darlington—a distance of 78 miles—with two intermediate repeater stations. The radio equipment operating on a frequency of 7500Mc/s is to be supplied and installed by Marconi's and the carrier equipment by A.T.E. The system is designed for a maximum capacity of 300 telephone channels, but initially 180 will be in operation.

**Ireland's first centimetric radio link for trunk telephone transmission**, which was installed by S.T.C., has been brought into service. The 7400-Mc/s system, which links Galway, Cappataggle and Athlone, can handle 240 telephone circuits on each of two bothway radio-frequency channels.

**Anglo-Swedish Link.**—The Electronic Apparatus Division of A.E.I. has been appointed sole agents in the U.K. and the Commonwealth (except Canada) for the Carousel random access magnetic-tape memory manufactured by Facit Electronics AB, of Sweden. A.E.I. will also handle the transistorized high-speed tape punch and reader made by Facit.

**Decca wind-finding radars (five)** and a weather radar have been ordered by the British Government for deployment along the air route Ankara-Teheran-Karachi as a contribution under its programme of technical assistance to the regional countries of the Central Treaty Organization. Decca wind-finding radar has also been ordered by the government of Indonesia for its Meteorological Department.

**Ever Ready's consolidated net profit** for the year ended in February, after all charges, including taxation, amounted to £1,706,526, an increase of £155,544 on the previous year's figure. The taxation charged was £1,368,932.

**Currys**, the retail radio and cycle company with a total of 325 branches, report a record group profit for the year ended on January 28th of £1,516,467 before taxation. This figure was an increase of £313,700 on the previous year. The total capital and reserves of the company and its subsidiaries is £5,710,791.

**A. H. Hunt (Capacitors) Ltd.**, which this year celebrates its silver jubilee, reports a gross trading profit for 1960 of £487,397.

**Simms Motor and Electronics Corporation**, of which N.S.F., Cawkell Research & Electronics and Dawe Instruments are subsidiaries, records a group net profit of £702,647 in 1960 against £489,490 the previous year.

**Johnson Matthey** are now able to supply scandium, yttrium, and most of the 14 rare earth metals in sheet form in thickness down to 0.001in and with a maximum width of three inches. The sheet is available either cold worked or annealed.

**SCI Designs Ltd.**, 30-34 Ingate Place, Queenstown Road, London, S.W.8, has been formed to produce economically transistor inverters and converters to specifications outside the standard ranges already on the market.

**Hammarlund Manufacturing Co., Inc.**, the well-known New York manufacturers of telecommunications receivers, this year celebrate fifty years in the radio industry.



# Versatile Stereophonic Pickup

NECESSITY FOR LOW TIP MASS

By J. WALTON\*

**T**HE July issue of *Wireless World* contained a report of some preliminary research which is used here as the basis for the design of a stereo pickup to track without impairing the recorded modulations. As will be shown, very few stereo pickups are at present capable of reproducing all that is recorded on a modern stereo disc.

Now, the main conclusions drawn from the above-mentioned work were (a) that the relation between tracking weight and stylus radius was apparently a linear one (*not* a square law) as far as record reproduction is concerned, and (b) that the motion of the record advantageously affected the upper weight limit for elastic tracking.

(Unfortunately certain errors were made in this article, namely that in Figs. 5, 11 and 12 the "stylus friction" is in fact the side thrust. In order to obtain the stylus friction the values given should be multiplied by 1.8. Similarly, apparent inconsistencies between Figs. 6, 7 and 8 arise because in general the stylus radii quoted are nominal values only and in particular the "0.0005"-in radius stylus used for the results of Fig. 6 had a larger radius than the other "0.0005"-in styli.)

It should be noted that many of the stylus indent measurements were in the region of 1.5 micro-inches (which is about one-tenth of the wavelength of light) and are near the limit of audibility in relation to any signal or noise content of the present record groove. Consider a signal recorded at the standard level of 1cm/sec at 1kc/s. The useful range of a normal stereo record on standard reproducing equipment may be from +26dB to -26dB referred to this, where the requirement for the groove not to be inclined at more than 45° to its unmodulated direction (so that the stylus does not ride obliquely up the groove wall) sets an upper limit on velocity, and amplifier and recording tape noise and reproducing turntable rumble set a lower limit. It should be noted that the disc material itself as "seen" by the stylus has a surface roughness that is less than 1/20th of the wavelength of light.

Consider a signal that is still usefully audible, e.g. a 10kc/s tone recorded at a level corresponding to a

Fig. 1. Stylus in an unmodulated groove. *S* is the stylus stress.

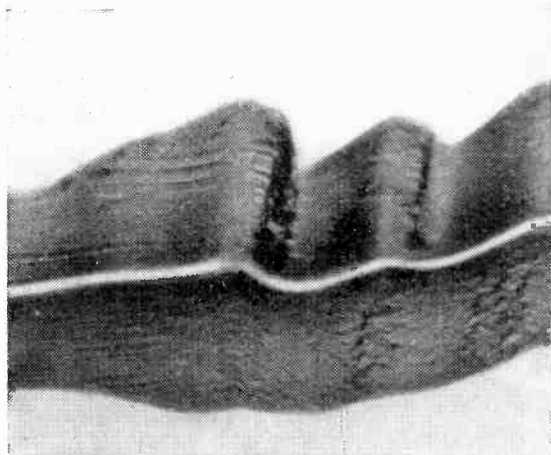
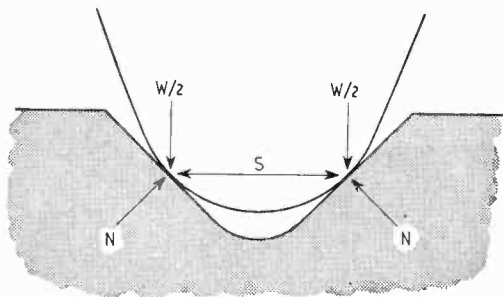

Fig. 2. Optical micrograph of an unplayed record with a fantastic modulation velocity—since the groove turns a complete right angle! No names—no pack drill—and no guesses please.

velocity of 20dB below a 1cm/sec, 1kc/s tone. The 10kc/s recorded level (C.C.I.R.) will be 5cm/sec minus 20dB. This corresponds to an amplitude of  $0.5/2\pi \times 10^4$ cm or  $3 \times 10^{-6}$ in, which is  $1/4$ th of the wavelength of light. The elimination of tape noise and reproducer turn-table rumble could make the present gramophone record capable of a range of nearly 70dB since the above signal could ideally be reduced a further 15dB or so before it merged with the minute surface roughening of the vinyl pressing caused by the action of even the best recording cutters. Recourse to an indenting process for the recording of a master record might conceivably add a few more decibels to this already enormous possible range, or rather the improvement might be used in conjunction with a smaller groove to give an extended playing time.

Considering the above and on examination of an electron micrograph (Fig. 10) it appears that, at up to about 2 gm force on a "half-thou" stylus tip and normal to the plane of the record material, the deformation of the record even after repeated playings is one of depressing the surface irregularities to even greater smoothness and is not of a magnitude that exceeds such original roughness as may exist. This is confirmed audibly, since below about 1-gm tracking force there appears a rather more transient, crackly sort of surface noise on the first few playings of "mint" discs. So if we consider an unmodulated groove (Fig. 1) we find that, for the normal reaction *N* on the groove wall not to exceed 2gm, the stylus force *W* must be below  $2N/\sqrt{2} = 3$ gm.

Now considerable controversy is apparent over the

\*Decca Record Co., Ltd.

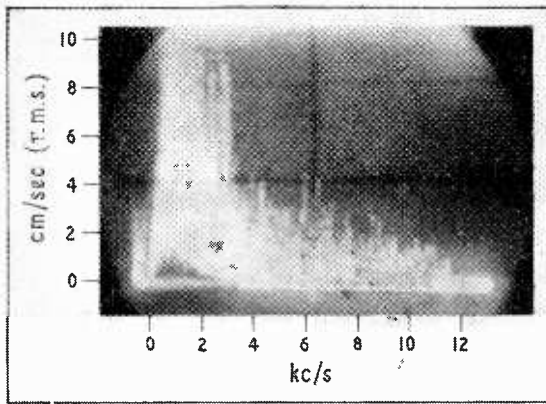

Fig. 3. Several minutes time exposure of output (in terms of modulation velocity) of a 1½-gm pickup with a 0.4mgm tip mass when playing Tchaikovsky's 1812 Overture.

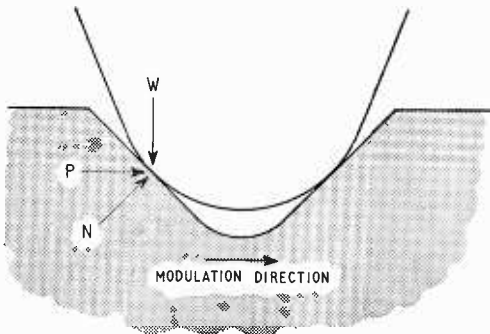

Fig. 4. Stylus in a groove modulated laterally (rightwards)

extent of recorded modulations, particularly in the upper register, and this can become a weak link in the chain of factors involved in a pickup design. Signals as large as 20cm/sec at 10kc/s have been mentioned and, of course, examples such as shown in Fig. 2 (not a Decca disc!) can be found. Fig. 3 however shows several minutes time exposure of velocities on an oscilloscope when Tchaikovsky's 1812 Overture is reproduced with a 1½-gm pickup having 0.4-mgm tip mass. This shows a common feature of no velocities greater than 4cm/sec r.m.s. above 2½ kc/s.

Even where there are higher levels, the radius of curvature of the modulation soon becomes less than that of the stylus at low groove speeds. At the condition where the groove curvature is the same as the stylus radius the acceleration would be infinite if the materials were infinitely hard. Now the maximum radius of curvature of a sinusoidal modulation =  $S^2/2\pi fV$  where S is the groove speed, f the frequency and V the peak velocity of modulation. Therefore, for example, for a 0.0006-in radius stylus and a 45° 10-kc/s signal, even at an average diameter of 8in, the r.m.s. velocity at which the modulation curvature is equal to the stylus radius is given by  $(\pi \times 8 \times 2.54 \times 33\frac{1}{60})^2/2\pi \times 10^4 \times 6 \times 10^{-4} \times 2.54\sqrt{2} = 9\text{cm/sec}$ .

From this set of conditions on, the stylus cannot possibly trace, let alone track, to say nothing of the

inevitable damage to the record. However, consideration of even some of the better pickups now available shows that they often fall far short of much more modest requirements than those of ultimate physical possibility which should have no place on a truly high-quality recording.

Let us consider the Decca frequency test record (SXL 2057) which, with its 5cm/sec r.m.s. at 10kc/s towards the outer diameter of the disc, presents a criterion for tracking capabilities which should surely be universally acceptable as a minimum requirement at least. To find out what tip mass is necessary to track this level of modulation (either laterally or at 45°) with not greater than 2 gm force normal to the groove wall consider first the lateral case (Fig. 4).

If P is the accelerating force, then at the tracking limit, since the groove wall is at 45°

$$P = W$$

$$\text{If } N \leq 2\text{gm}$$

$$\text{Then } W = N/\sqrt{2}$$

$$\leq 1.4\text{gm}$$

$$\text{Now } P = m\alpha$$

where m is the stylus tip mass and the recorded acceleration

$$\alpha = 2\pi \times 10^4 \times 5\sqrt{2}\text{cm/sec}^2$$

$$= 450\text{g (neglecting the small effect of groove curvature due to tracing with a finite stylus)}$$

$$\therefore m \leq 1.4/450\text{gm}$$

$$\leq 3.1\text{mgm}$$

If a pickup is to track this level of modulation at 45°, the force supplied by the tracking weight W must be sufficient to accelerate the tip mass to 450g when the wall is receding (see Fig. 5a).

$$\therefore W/\sqrt{2} = 450m \quad \dots \quad (1)$$

When the modulated wall is advancing (Fig. 5b), since there is no vector of the accelerating force P normal to the unmodulated groove wall, there is

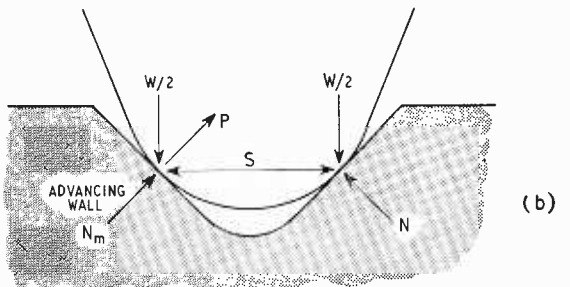
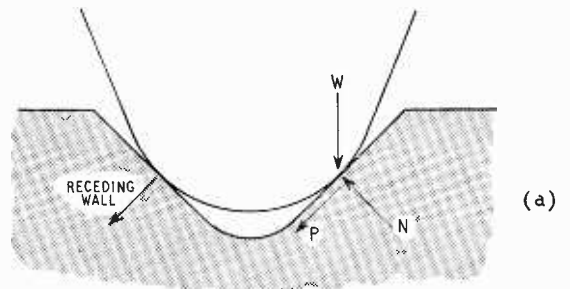

Fig. 5a. Stylus in a 45° modulated groove with the modulated wall (on the left) receding.

Fig. 5b. Stylus in a 45° modulated groove with the modulated wall (on the left) approaching.

no change in the static reaction normal to this wall, and so  $W$  is equally distributed on to both walls. Thus the reaction normal to the advancing wall

$$N_m = P + (W/2 + S)/\sqrt{2} \quad \dots \quad (2)$$

Now  $S = W/2$ ,  $P = 450m$  and  $N_m$  must be  $\leq 2gm$

$$\therefore N_m \leq 2 = 450m + W/\sqrt{2}$$

$$\therefore m \leq 2/900gm \text{ from equation (1)}$$

$$\leq 2.2mgm$$

And substituting  $m$  in equation (1)

$$W \leq 450\sqrt{2} \times 2.2/1000$$

$$\leq 1.4gm$$

This is for a pickup tracking without any other, lower, frequency to cope with at all, so in order to track even the test record levels of modulation under practical "music conditions" without any groove deformation at all the pickup must have a combination of a tip mass of 1 mgm, a compliance of  $10 \times 10^{-6}$  cm/dyne (see *Wireless World* for April 1959, p. 182) and a tracking weight of  $1\frac{1}{2}$  gm. If this pickup has also some mechanical resistance incorporated in the stylus movement (which I would consider desirable from an operational point of view, and almost essential for smooth response in a piezo-electric type of pickup) then the above impedance figures must be made still smaller. The output from such a pickup becomes proportionately smaller, and its use becomes restricted to more specialized amplifier equipment. It was considered therefore that provided that the waveform suffers no permanent deformation and that the groove itself is merely smoothed after a hundred or so playings, the most useful arrangement could be achieved. To this end, whilst it is clear that the tip mass must remain less than 2 mgm, the tracking weight could conceivably be raised to 3mgm, the extra tracking weight either in itself or with its associated lower compliance not causing any differential deformation of the groove and thus no distortion of the waveform.

### Comparative Assessments

Now the best available ceramic-element cartridge which audibly tracks at the bottom limit of its recommended 2 to 4 gm but has a tip mass of 3mgm was assessed on the above theoretical basis. (The harmonics of non-tracking above 7kc/s, whilst not directly audible, are still the result of the most critical record wear and lead to loss of clarity.) In the  $45^\circ$  case a tracking weight of  $450 \times 3\sqrt{2}mgm = 1.9gm$  is required. This means that for practical tracking purposes, even allowing only for a vector addition of low- and high-frequency modulation forces, the tracking weight is required to be  $1.9\sqrt{2} = 2.7gm$ . (A vector addition not only gives the "benefit of the doubt" to the 3-mgm pickup, but is also consistent with the direct comparison of both the 3-mgm and 1-mgm styli at the same tracking weight, as shown photographically.) With a 2.7-gm tracking weight a 3-mgm stylus produces a normal reaction (see equation 2) of  $450 \times 3 + 2.7/\sqrt{2} = 3.25 gm$  on the advancing modulated wall. Thus, according to the figures determined in the previous article, at the crest of the modulation wave the indentation rises sharply to between 4 and 10 micro-inches compared to practically nil elsewhere. Now the peak amplitude of the modulation is given by  $5\sqrt{2}/2\pi \times 10^4 cm =$

44 micro-inches. Thus up to 25% of the 10 k/cs modulation on the test record will be removed on the very first playing. If the tracking weight is increased the indentation is greater; if it is decreased the stylus cannot follow the undulation and the impacts between stylus and groove cause even greater destruction. Thus it is impossible to track even the test record modulation levels with a pickup which has a tip mass of 2 mgm or over.

Optical micrographs demonstrate this with considerable visual emphasis (see Figs. 6, 7). They also show that after 250 playings of the new pickup with the 1-mgm stylus, at the same tracking weight of

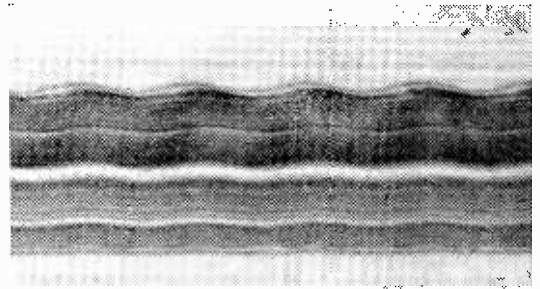

Fig. 6. Optical micrograph (X300) of un-played 5cm/sec r.m.s. 10kc/s stereo test record groove.

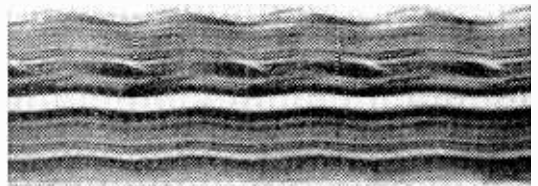

Fig. 7. Optical micrograph (X300) of 5cm/sec r.m.s. 10kc/s stereo test record groove taken after one playing with a 3-mgm stylus at 2.7gm tracking weight.

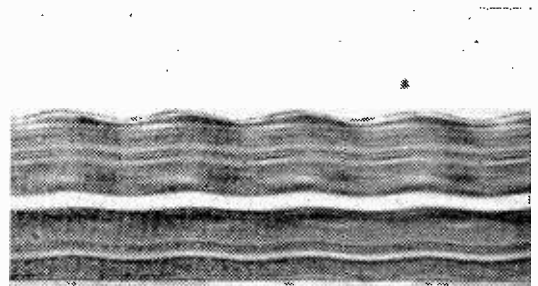

Fig. 8. Optical micrograph (X300) of 5cm/sec r.m.s. 10kc/s stereo test record groove after 250 playings with a 1-mgm stylus at 2.7gm tracking weight.



Fig. 9. Section of a flattened electron micrograph impression (X2400) of 5cm/sec r.m.s. 10kc/s stereo test record groove taken after one playing with a 3-mgm stylus at 2.7gm tracking weight. While the width of the indent shows a depth of permanent deformation equal to nearly half the amplitude of the modulation, the actual path of the stylus described on the unmodulated wall indicates that it penetrated to a depth nearly equal to that of the modulation.



Fig. 10. Section across similar groove to Fig. 9 taken after 250 playings with a 1-mgm stylus at 2.7gm tracking weight. The path of the stylus is only perceptible as a smoother surface.

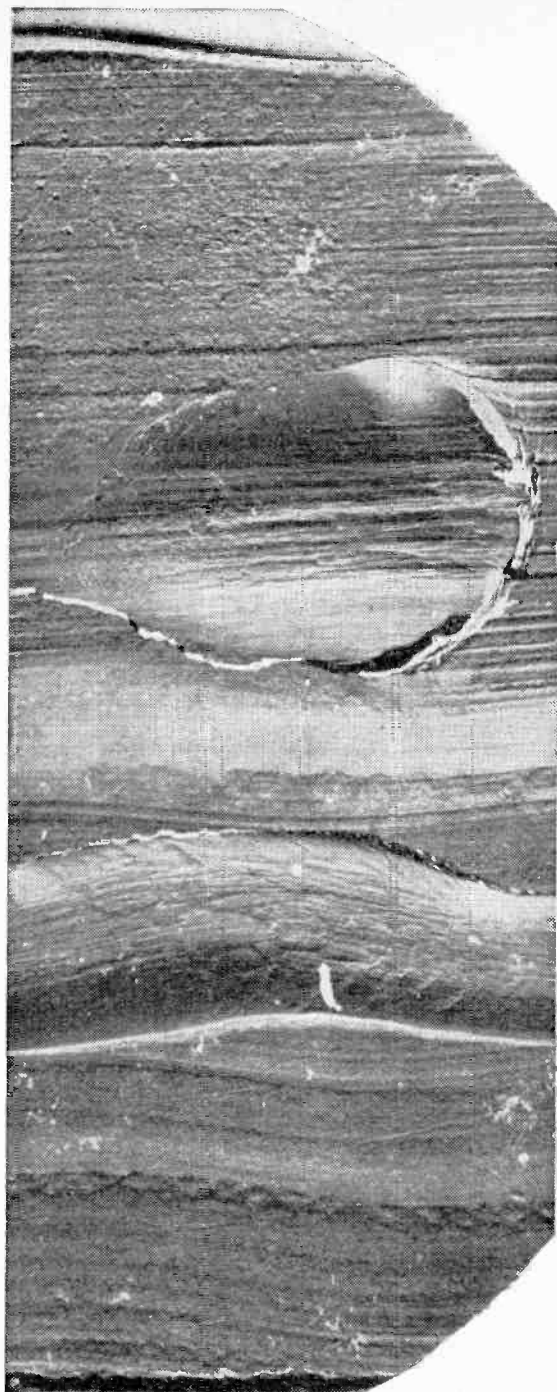

Fig. 11. Section across similar groove to Fig. 9 after repeated playings with a 3-mgm stylus at 2.7gm tracking weight. It can be seen from the path of the stylus described on the unmodulated wall, and from the fact that there is no loss of contact, that the original modulation has been completely obliterated.

2.7 gm, there is no practical deterioration of the groove (see Figs. 6, 8).

Electron micrographs verify the above quantitatively showing that even at the first playing the 3-mgm stylus does not track the test record but ploughs through the crests  $40^\circ$  out of phase with the original signal, penetrating to a depth equal to that of the original modulation and leaving a depth of permanent deformation equal to nearly half of this (see Fig. 9). They also show that after 250 playings with the 1-mgm stylus at the same tracking weight of 2.7 gm, the groove surface is if anything improved and the waveform itself is nowhere distorted (see Fig. 10). After repeated playings of the 3-mgm stylus it can be seen from Fig. 11 that not only has the active groove wall been indented to a depth equal to that of the original signal and  $120^\circ$  out of phase with it, but that a modulation has been indented on the inactive groove wall to a depth of the order of the amplitude of the "wanted" signal. *In other words, a large stylus tip mass could eventually ruin the upper frequency separation of a stereophonic disc, no matter what the channel separation of the pickup itself might be.*

With the exception of Fig. 2 all these micrographs are of the 10kc/s band of the Decca stereo frequency test record (SXL 2057). This photographic evidence has been prepared by Dr. P. Chippindale of the Royal College of Advanced Technology, Salford, by a process which he has specially developed. The electron micrographs are taken from carbon replicas of the groove walls. During the replicating process the carbon film becomes somewhat flattened and therefore some of the indentations will in fact be deeper than they appear. There is also some buckling at the bottom of the groove (appearing lighter). Small cracks occasionally appear in the replica because of the very delicate nature of the carbon film. In spite of this the lines left by the cutter still provide a datum for accurate quantitative interpretation.

### Stylus Arm Design

With the validity of a 1-mgm half-thou stylus, tracking at 3 gms thus proven, the remainder of the pickup design followed therefrom in a similar manner to that described for a mono pickup in *Wireless World* for April 1959. The problem of achieving adequate channel separation is considerably aggravated by the flexible stylus arm used in this type of design, for here the transducing elements are more free of positive control by the record groove. This was particularly confusing in the early stages of development when it was found that transmission of impulses from the stylus to the elements was taking place through the rear of the assembly. When this was eliminated the separation became the usual 20dB over the main mid-audio range. The suspension pocket was then arranged for practically aperiodic response to amplitude excitation from its front end. A frequency response within  $\pm 1$ dB to 12 kc/s could be achieved experimentally and  $\pm 2$ dB overall for production, practically regardless of how flimsy a stylus arm was used. Before further experiment with the stylus the transmission geometry was finally adjusted (by angling the ceramic elements and offsetting the  $45^\circ$  transmission arms to them) to allow for its dynamic flexing conditions and to achieve maximum separation. The complete complex moulding (see Fig. 12) is a feat of modern tool-making

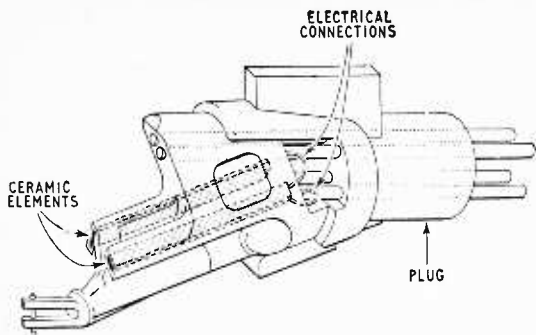

Fig. 12. Schematic side view of new stereo pickup with cover removed.

for which all credit must go to Ablex Tools Ltd. whose skill and patient co-operation have made it possible. Although the form and function of this "suspension" is long since finalized, development is still proceeding which should eventually lead to automatic production of the whole pickup.

### Vertical Motion

One problem of a stereophonic pickup stylus is that its vertical motion must be such as to cause negligible vertical tracking error distortion (see *Wireless World* for July 1960, p.340).

Several stereo pickups have nearly 30° such error which would be considered intolerable by lateral tracking standards. In order to improve this motion and still give tolerance on the clearance of the remainder of the pickup above the record surface, a "parallel-motion" linkage system was arranged in the stylus arm (see Fig. 13). By using a material of lower mechanical resistance for the stylus arm than for the remainder of the transmission, the linkage system is made more operative where velocities are larger and tracking errors become more important. The actual improvement is only four or five degrees for slow vertical motion, but is greater when the decoupled tip mass moves more independently of its support, i.e. when the parallel arms flex most. This construction also has the advantage of reducing the vertical tip mass (and increasing the vertical compliance) for a given longitudinal stiffness. The final version will have the stylus moulded *in situ* (patent pending) so as to give greater robustness at this point.

Since all-round usefulness of the pickup is an

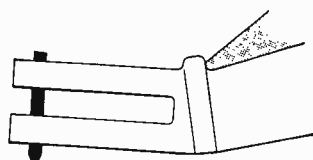

Fig. 13. "Parallel motion" stylus arm linkage system.

important consideration the stylus is made in replaceable form. In fact special materials have been produced with the aid of I.C.I. Plastics Division and is possible by changing the stylus arm material, to change the tracking weight, tip mass, compliance and output of this pickup at will. A stylus with a 0.6-mgm tip mass and a tracking weight of 2 gm giving a pickup output of 30 mV/cm/sec will be available, as well as the standard one with diamond tip, 1-mgm tip mass, tracking weight of 3 gm and an output of 60 mV/cm/sec (i.e. about  $\frac{1}{2}$  V from many recordings).

### Measuring Tip Mass

The figures quoted are for the "total effective tip mass" and it may be as well to mention here that the usual methods of measuring tip mass either by finding the upper resonance of the pickup (stylus-groove resonance) or its free resonance (with its own compliance) do not work well with this type of pickup, owing to its decoupled stylus tip and somewhat distributed mass. The methods used were those of measuring the pickup's reaction to groove acceleration and also watching its tracking performance by observing its output wave-shape on an oscilloscope, whilst varying the tracking weight (on a previously unplayed test record). This gives the effective tip mass at any frequency and will include some vector addition due to mechanical resistance in the stylus arm.

In fact it is more important to consider not only the component parts of the mechanical impedance of a pickup stylus (i.e. mass, compliance and resistance) but also its impedance over the whole frequency range. Fig. 14 shows a limiting curve according to record modulation levels which takes into account the necessity of much lower strains on the smaller undulations at the high-frequency end of the scale. It can be shown in practice that beyond the region 4 to 7kc/s there is a rapid falling off of the recorded amplitude and wavelength combined with an increase in the acceleration, so that above this region the effects of replay deformation and wear become much more serious. The tracking performance of one of the better 5-gm ceramic pickups is shown in Fig. 14 as well as that of the 2-gm pickup with the 3-mgm stylus mentioned before. It is interesting to note the rise in tracking impedance due to an internal resonance of the former pickup compared with the smooth curve of a "decoupled" stylus. A rough comparison might be made by listening to the needle talk from a

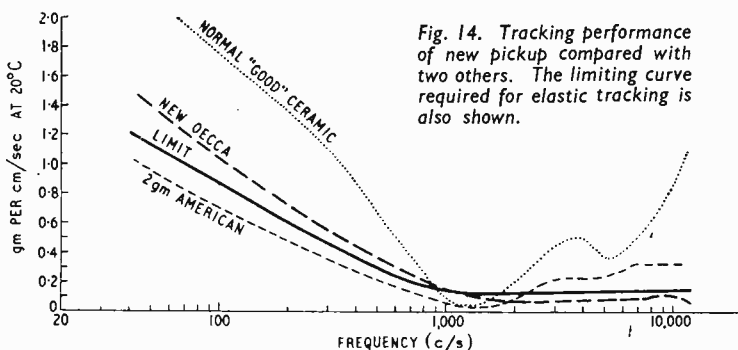

Fig. 14. Tracking performance of new pickup compared with two others. The limiting curve required for elastic tracking is also shown.

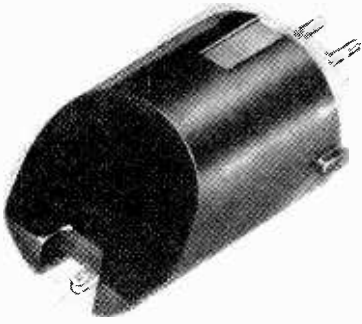

Fig. 15. Photograph of new stereo pickup.

frequency record. I specify frequency record because it is then possible to distinguish between that impedance that is resistive and may make a louder noise on mid-frequencies without damaging the record, and the upper register noise which indicates the first and most critical source of record damage.

Whilst on the subject of stylus construction it may be of interest to mention that the actual stylus tip has been made visible over a wide angle in order to ease accurate positioning of the pickup on to the record (see Fig. 15).

A criticism of piezo-electric type pickups may be their variability with temperature. In this case the softening of the plastic stylus arm may be said to be an advantage in that the effective tip mass decreases somewhat as the compliance of the stylus increases with temperature. Thus the vinyl record groove is appropriately under proportionally less strain at higher temperatures. The pickup has been operated satisfactorily, response- and separation-wise, at temperatures of 55°C, when the output is reduced by about 7dB on the normal 20°C room temperature.

A universal fixing bracket enables the pickup to be mounted in record changers where the arm may

be balanced, the 3½ gm of the pickup head itself being then added and used as the tracking weight. For the cheaper changers that need several grams to operate their mechanisms alone, a special high-output stylus will be available that can withstand over 6 gm playing weight.

This should prove to be a very inexpensive stereophonic pickup and to take advantage of this a suitable pickup arm for both transcription and changer purposes is also being developed which should then enable both types of users to operate at the lighter tracking weights.

Production testing of a pickup of this sort could add appreciably to its cost and offset much of the gain of its simple assembly. The production of a special test record enables this pickup to have a thorough test on production that would otherwise hardly be economic even on the most expensive pickups.

It is felt that Dr. Chippindale's photographic evidence shows that the considerable research and development which has laid the basis for this pickup has borne useful fruit.

## Transistor Data

COMPILED primarily as an adjunct to the Avo Transistor Analyser, "International Transistor Data Manual" contains details, we estimate, of about 2,500 transistors. In some cases the parameters listed are somewhat limited in scope; but generally should serve to indicate suitable types and for the working out of rough circuit values. In the first part of the data types are classified into American and European (pp. 16-65) followed by a short list of CV types and some connection details. The remaining 78 pages form a "stop-press" unclassified list. A most valuable feature of the book is a list of manufacturers names and addresses and, in the case of overseas firms, their agents or subsidiaries in Great Britain.

The "Avo International Transistor Data Manual" edited by C. E. Bull and published by Avo Ltd., Avocet House, 92-96 Vauxhall Bridge Rd., London, S.W.1, costs £1 15s by post.

## SHORT-WAVE CONDITIONS

Prediction for August

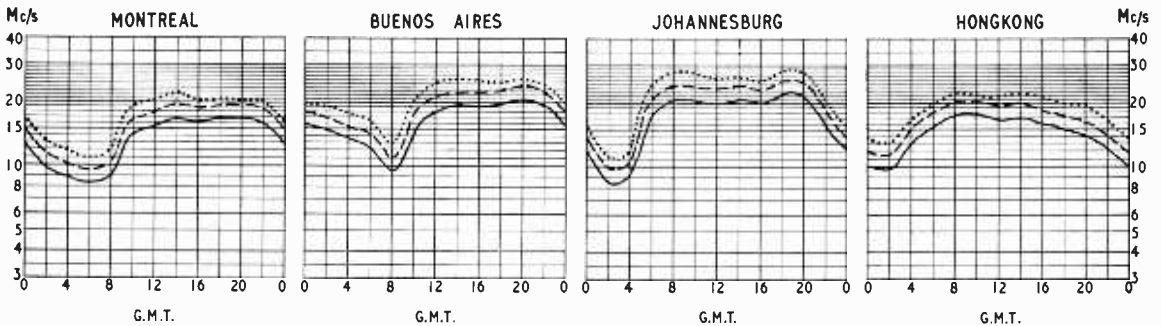

THE full-line curves indicate the highest frequencies likely to be usable at any time of the day or night for reliable communications over four long-distance paths from this country during August.

Broken-line curves give the highest frequencies that will sustain a partial service throughout the same period.

- ..... FREQUENCY BELOW WHICH COMMUNICATION SHOULD BE POSSIBLE FOR 25% OF THE TOTAL TIME
- PREDICTED MEDIAN STANDARD MAXIMUM USABLE FREQUENCY
- FREQUENCY BELOW WHICH COMMUNICATION SHOULD BE POSSIBLE ON ALL UNDISTURBED DAYS

# TECHNICAL NOTEBOOK

**Two-Signal Bridges** are discussed under this title in an article by G. W. Short in the December 1960 issue of *Electronic Technology*. In a normal four-arm bridge, either the signal source or the detector must be left floating since they are connected to opposite bridge diagonals. This could, in principle, be avoided by connecting a rectifier in the normal detector position across one bridge diagonal and placing the detector at an earthed point either in series with one of the arms or in series with the signal source. With this arrangement, when the bridge was off-balance the signal across the rectifier would result in a d.c. output and signal harmonics being produced in the detector. Unfortunately the exact balance point would be difficult to determine by this method since rectifier efficiencies are low at low input levels. This difficulty can be avoided by using two very-different bridge input frequencies and detecting the intermodulation products (produced by the rectifier) between the signal and other input frequency (their differences frequency, for example). If the bridge is nearly balanced at one input frequency, it will be well out of balance at the other. This other frequency will thus produce a substantial signal across the rectifier so that its intermodulation efficiency will be high. In a somewhat different system, one of the intermodulation frequencies produced by the rectifier is used as the signal frequency so that the rectifier then acts virtually as a compact floating oscillator. Another advantage of using two input frequencies is that the input and detector frequencies are different and so can be carried on the same cable. This would, of course, be very useful for making measurements at a distance.

**New Display Device:**—When mechanical stresses are applied to a flat plate of piezoelectric material, electric charges are developed on the face of the plate. Electroluminescence involves the excitation of a phosphor by the application of an electric field, which causes the phosphor to give out light. The new device, developed by Stephen Yando of General Telephone and Electronics Laboratories, Inc. (U.S.A.), combines these effects, consisting of a thin, flat panel composed of a piezoelectric ceramic material, one surface of which is coated with a layer of electroluminescent material. When signals are applied to electrodes on the edges of the panel, acoustic travelling waves are propagated in the ceramic and

the electric fields accompanying the acoustic waves cause the electroluminescent layer to produce a "spot" of illumination on the panel. The position of the spot is controlled by varying the relative timing of the electrical pulses to produce a wave pattern and the light intensity is modulated by varying the electric field applied by a transparent conductive layer covering the electroluminescent layer.

**High-conductivity Springs** are a necessity in many miniature components where, for instance, the current-carrying capacity of a contact may well be limited by the rise in temperature due to its internal power loss. Johnson Matthey have recently introduced a new alloy, Mallory 53, which has mechanical properties at least as good as those of the common phosphor-bronze materials, combined with electrical conductivity between 40% and 45% of that of the interventional annealed-copper standard. The thermal conductivity, too, is high and this aids the cooling of spring contacts. Mallory 53 is also less prone to the formation of high-resistance oxide films at high temperatures.

**Aerial Matching:**—As is well known, the impedance of an aerial drops considerably when parasitic elements are fitted: so much so, in fact, that the impedance of a folded dipole, made from one length of tubing and consequently of constant diameter, falls from  $300\Omega$  to  $50$  to  $70\Omega$  when used in a Yagi array. So that different-diameter sections are not necessary to restore the impedance to  $300\Omega$  for the matching of ribbon feeder Antiference are using transformers wound on dumb-bell-shaped ferrite sections. These transformers drop into the connection box on the aerial insulator, mounting on the terminals therein. Alternatively  $75-\Omega$  coaxial cable can be used and the transformer (which now has to transform unbalance to balance also) is fitted at the set end of the feeder in a small moulded box.

**Character Recognition** by autocorrelation is being investigated by Dr. M. B. Clowes and Mr. J. R. Parks at the National Physical Laboratory. The points of overlap between displaced rotating images of the character are determined. Straight lines will tend to overlap along their length at one angular rotation position whereas curves will tend to overlap at one point over a range of

angular rotation. The position of straight lines and curves can thus be found and the character recognized.

**Microwave Mekometer** is an instrument developed by the National Physical Laboratory for the measurement of distances above 10 metres to an accuracy of a few thousandths of a centimetre. A crystal of ammonium dihydrogen phosphate is placed in the electric field of the output of a magnetron, oscillating at  $9,300\text{Mc/s}$ . Plane-polarized light, obtained from a xenon flash, is transmitted by the crystal, but by virtue of the properties of the crystal in an electric field, the emergent beam is elliptically-polarized, and the direction of rotation is reversed twice in each cycle of the microwave oscillation. The magnetron and flash tube are pulsed to avoid damage to the crystal. The polarization-modulated light beam is aimed at a distant reflecting prism—from which it is returned, via a light path of variable length, to the crystal. On emerging from the crystal, the elliptical polarization is either enhanced or degenerated, depending on the relative phases of the modulation and the microwave field across the crystal. The resultant signal is focussed on to two photoelectric detectors—in the case of one, via a polarizer. The output of the detector fed via the polarizer will vary in intensity due to the effect in the crystal, and the difference in the two signals, displayed on a meter, is a measure of the distance between the crystal and the reflector in relation to the modulation wavelength. If the process is performed at three settings of the magnetron frequency, and a null obtained on the meter each time by use of the micrometer-controlled variable light path, it is possible to calculate the distance.

**New Superconductor** developed at the Bell Telephone Laboratories—a niobium-tin compound ( $\text{Nb}_3\text{Sn}$ )—remains superconducting at much higher magnetic fields and temperatures than other known substances—in fact up to at least 88,000 gauss and  $18^\circ\text{K}$ . This compound should thus be of great value in making very-low-loss high-flux solenoid magnets.  $\text{Nb}_3\text{Sn}$  is normally very brittle, but Bell have developed a method of making it inside a hollow niobium tube which is already formed in the required solenoid shape. With this method of manufacture, the superconducting  $\text{Nb}_3\text{Sn}$  can carry currents of over  $150,000\text{A/sq cm}$ .



# Transistor Measurements

## 2.—CONTINUATION OF THEORY, MEASUREMENT METHODS

By C. BAYLEY

**L**AST month we saw how four-pole and the basic "T" transistor parameters are related to actual quantities measurable in a circuit. In this concluding instalment we shall examine hybrid- and conductance-parameter terms and consider some means of measuring their various values.

### Basic Parameters Expressed in Conductance and Hybrid-parameter Terms

Very often transistor parameters are expressed by conductance terms because in high- $\alpha$  junction transistors, due to the very small alternating base current, it is easier to create constant-output or -input voltage conditions by short-circuiting the respective circuits to a.c. No formulae will be deduced and only the basic principle of setting out equations is given.

Looking back to Fig. 4 (repeated here for convenience) and the general relation between  $I_1 v_1 I_2 v_2$  (using again the general notation, as "1" might

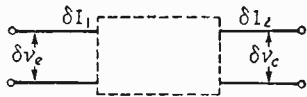

Fig. 4. Four-pole-parameter representation of transistor. Here measurable quantities are labelled generally 1 (input) and 2 (output) and replaced by notation appropriate to mode of connection. For instance, mode: common base, then 1 becomes e and 2 becomes c (repeated).

indicate either emitter or base quantities) a different set of equations can be written:—

$$I_1 = f_1(v_1 v_2) \dots I_2 \text{ constant}$$

$$I_2 = f_2(v_1 v_2) \dots I_1 \text{ constant}$$

which, rewritten with conductance terms, become:—

$$I_1 = G_1(v_1 v_2) \dots \dots \dots (29)$$

$$I_2 = G_2(v_1 v_2) \dots \dots \dots (30)$$

Operating by increments now,  $\delta I_1$  and  $\delta I_2$  can be expressed as:

$$\delta I_1 = \frac{\partial I_1}{\partial v_1} \delta v_1 + \frac{\partial I_1}{\partial v_2} \delta v_2 \dots \dots (31)$$

$$\delta I_2 = \frac{\partial I_2}{\partial v_2} \delta v_1 + \frac{\partial I_2}{\partial v_2} \delta v_2 \text{ and } \dots \dots (32)$$

$$\delta I_1 = g_{11} \delta v_1 + g_{12} \delta v_2 \dots \dots (33)$$

$$\delta I_2 = g_{21} \delta v_1 + g_{22} \delta v_2 \dots \dots (34)$$

$g_{11}$   $g_{12}$   $g_{21}$  and  $g_{22}$  are the input, feedback, forward and output conductances of the transistor for  $\delta v_2 = 0$   $\delta v_1 = 0$   $\delta v_2 = 0$  and  $\delta v_1 = 0$  conditions respectively (short-circuited output or input circuits)

As with the relation between internal resistances and four-pole  $r$  parameters, there is similar relation between conductance four-pole parameters (as above) and conductance parameters forming a  $\pi$  network.

Apart from  $\pi$  and T parameters which are used in

both the U.S.A. and this country there is also a  $\pi$  hybrid-parameter system, used mostly here. It is based on another, mixed set of equations such as:

$$v_1 = f_1(I_1 v_2) \dots I_2 \text{ constant} \dots (35)$$

$$I_2 = f_2(I_1 v_2) \dots v_1 \text{ constant} \dots (36)$$

After similar transformation as in the two foregoing cases, incremental relations for  $\delta v_1$  and  $\delta I_2$  can be expressed as:

$$\delta v_1 = h_1 \delta I_1 + h_r \delta v_2$$

$$\delta I_2 = h_i \delta I_1 + h_o \delta v_2$$

where four hybrid-parameters are defined as:

$$h_i = \frac{\partial v_1}{\partial I_1} = \text{input impedance with output short-circuited } (\delta v_2 = 0) \dots (37)$$

$$h_r = \frac{\partial v_1}{\partial v_2} = \text{the open-circuit voltage-feedback ratio } \dots \dots (38)$$

$$h_i = \frac{\partial I_2}{\partial I_1} = \text{the short-circuit current "transfer ratio" equal to } -\alpha \dots (39)$$

$$h_o = \frac{\partial I_2}{\partial v_2} = \text{output admittance with input open circuit } \dots (40)$$

### Measurement of $r_e$ , $r_b$ , $r_c$ and $r_m$

As has been said before, direct measurement of transistor parameters is not possible and four-pole parameters have to be measured first, then values for  $r_e$ ,  $r_b$ , etc. can be calculated from simple relations. The values of the various resistances might in certain cases be measured directly by use of impedance bridges; but sometimes it is more convenient to use an indirect method to measure alternating voltages and currents related to particular impedances, calculate the latter, and finally compute  $r_e$ ,  $r_b$ , etc.

In order to simplify the computing of  $r$ -parameters from impedances the common-base configuration is usually preferred for  $r_e$  and  $r_b$  measurement as then  $r_{12} = r_b$  (Eqn. 18) and with very close approximation  $r_{22} = r_c$  (Eqn. 19,  $r_c = r_{22} + r_{12}$   $r_{12} \ll r_{22}$ ). For measurement of  $r_e$  and  $r_m$  however, the common-emitter mode is more useful, as the emitter parameter  $r_e = r_{12}$  (Eqn. 26) in this case and  $r_m$  can be computed from the relation  $r_{22} = r_c - r_m$ : that is,  $r_m = r_c - r_{22}$  ( $r_{22}$  has to be measured first).

Therefore, to determine transistor  $r$  parameters, two measurements of  $r_{22}$  (output-characteristic slope) and two measurements of  $r_{12}$  (feedback-characteristic slope) are required, one each in the common-base and common-emitter configurations.

Considering the first indirect method, four main measuring arrangements are shown in simplified form in Fig. 6.

It is significant that the source of the small-signal

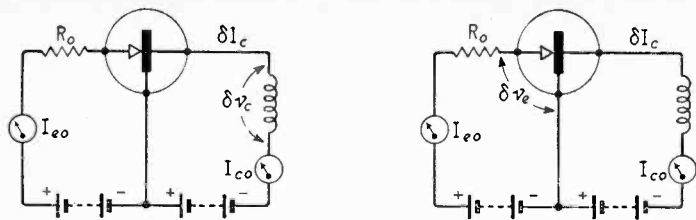

(a) Common-base mode  
 $r_{22} = \frac{\delta v_c}{\delta I_c}$   $I_{e0}$  constant

(b) Common-base mode  
 $r_{12} = \frac{\delta v_e}{\delta I_c}$   $I_{e0}$  constant

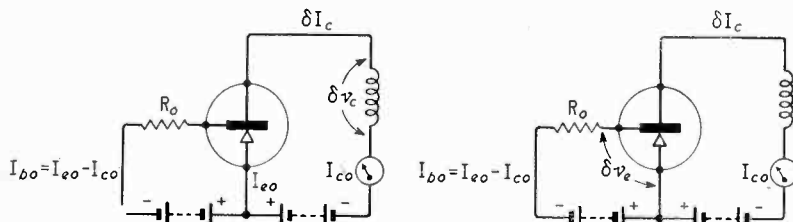

(c) Common-emitter mode  
 $r_{22}' = \frac{\delta v_c}{\delta I_c}$   
 $I_{b0} = I_{e0} - I_{c0}$  constant

(d) Common-emitter mode  
 $r_{12}' = \frac{\delta v_e}{\delta I_c}$   
 $I_{b0} = I_{e0} - I_{c0}$  constant

Fig. 6. Four main methods for the indirect determination of transistor parameters.

alternating voltage  $\delta v_c$  is always connected into the collector circuit and independent parameters are chosen for collector and emitter direct currents in the common-base configuration ( $I_{c0}$  and  $I_{e0}$ ). Corresponding currents in the common-emitter mode should be exactly the same; but instead of  $I_{e0}$  the base current  $I_{b0}$  (which is not an independent parameter as  $I_{b0} = I_{e0} - I_{c0}$ ) is shown. Measurements of the small alternating values of  $\delta I_c$ ,  $\delta v_c$  and  $\delta v_e$  should be made with a sensitive high-impedance valve voltmeter, to avoid affecting circuit working conditions. The level of  $v_e$  is often very low and, to combat noise and other undesirable effects that may affect the measuring device, a narrow-band pass filter tuned to the test frequency (usually 1kc/s) should be inserted in the measuring circuit.

Fig. 7 shows an example of how  $r_{22}$  and  $r_{12}$  for a p-n-p transistor may be measured in the common-base mode.

With selector switch "S" on the first position the signal  $\delta v_c$  is measured. When "S" is in Position 2 the voltage drop  $\delta v_2'$  across known resistor  $R_s$  (collector load) is measured, so determining the required  $\delta I_c$  as:

$$\delta I_c = \delta v_2' / R_s$$

In Position 3  $\delta v_c$  (which is feedback from collector circuit) is measured enabling us to compute  $r_{12}$ :—

$$r_{12} = r_b = \delta v_c / \delta I_c$$

Values for  $r_{22}$  and  $r_c$  would then be calculated from the first two measurements where

$$r_{22} = \frac{\delta v_c}{(\delta v_2' / R_s)} = R_s (\delta v_c / \delta v_2')$$

The main precautions to be observed in the circuit are to keep the value of the resistor  $R_o$  at least 100 times higher than estimated value of  $r_c$  and the value of  $R_s$  at least 100 times lower than  $r_c$  to fulfil conditions of open-circuit input (emitter) and shorted

output (collector) circuits with an accuracy of 1%.

The potentiometers  $R_1$  and  $R_2$  set the standing currents  $I_{e0}$  and  $I_{c0}$ .

Fig. 8 represents a more general arrangement. Here selector switch  $S_1$  carries out the same function as the one just described.  $S_2$  can be set to one of four positions for p-n-p transistor tests in the common-base and emitter configurations (Positions 1, 2) and the corresponding n-p-n transistor tests in Positions 3 and 4.

### Measurement of $\alpha$

Before discussing methods for measuring current gain, this must be defined by other transistor parameters. From a general definition of  $\alpha$ :

$\alpha = \delta I_c / \delta I_b$  (for collector circuit short-circuited that is,  $\delta v_c = 0$ ) and from the general four-pole relationship:

$$\delta v_c = r_{21} \delta I_b + r_{22} \delta I_c = 0$$

and

$$\frac{\delta I_b}{\delta I_c} = -\frac{r_{21}}{r_{22}} = \left| \frac{r_{in} + r_b}{r_c + r_b} \right|$$

In most practical cases it would be sufficient to know only  $r_c$  and  $r_{in}$  to calculate  $\alpha$ :—

$$\alpha = \frac{r_{in}}{r_c} \quad (r_{in} \text{ and } r_c \gg r_b)$$

But even so, this would involve the making of at least two measurements with different circuit configurations and as knowledge of  $\alpha$  is usually of great importance, a special arrangement for direct measurement is a practical proposition.

Fig. 9 shows two circuits for  $\alpha$  measurement. In (a), the transistor is connected in the common-emitter mode and a.c. is injected into the base circuit from the signal generator causing base and collector currents  $\delta I_b$  and  $\delta I_c$  respectively.

From the basic relation between current gain in common-emitter ( $\beta$ ) and common-base ( $\alpha$ ) configurations,

$$\beta = \frac{\alpha}{1 - \alpha} = \frac{\delta I_c}{\delta I_b}$$

and by simple measurement of  $\delta I_c$  and  $\delta I_b$ , the value of  $\beta$  can be calculated, and therefore  $\alpha$  as:

$$\alpha = \frac{\beta}{\beta + 1}$$

To measure currents  $\delta I_b$  and  $\delta I_c$ , the input voltage across  $R_1$  and  $R_2$  is exactly 10V (supplied from a signal generator) and assuming that  $R_s = 1M\Omega$ , base current

$$\delta I_b = 10/10^6 = 10\mu A$$

(The base-to-emitter resistance is of the order of a few hundred ohms and therefore the error introduced by its omission would be less than 1 part in  $10^3$ .)

Fig. 7. Measurement of  $r_{22}$  and  $r_{12}$  for a p-n-p transistor in the common-base mode.

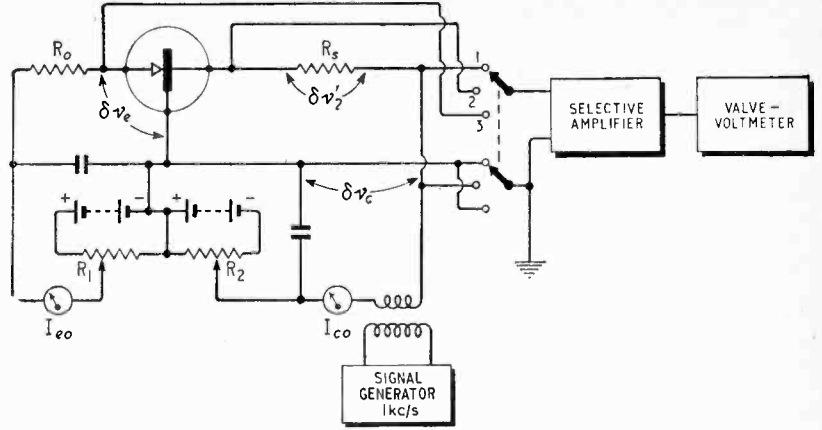

Fig. 8. General transistor-test circuit:  $S_1$  selects parameters to be measured whilst  $S_2$  (wafers c and d) sets common-emitter or common-base connections for both p-n-p and n-p-n transistors (supply reversed by a, b, e and f).

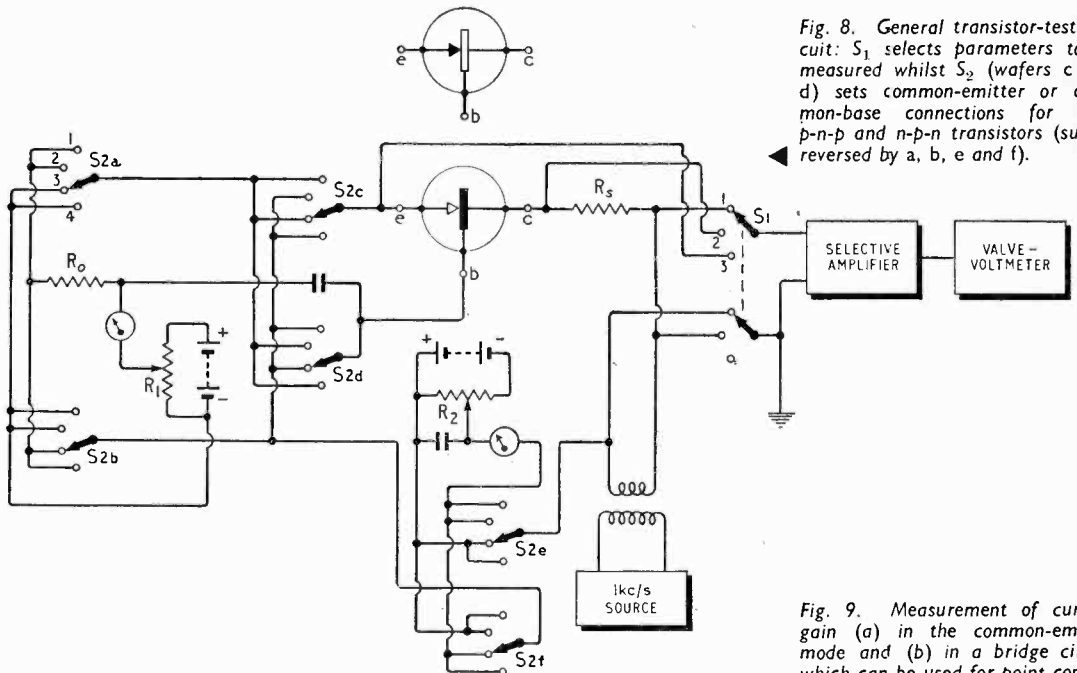
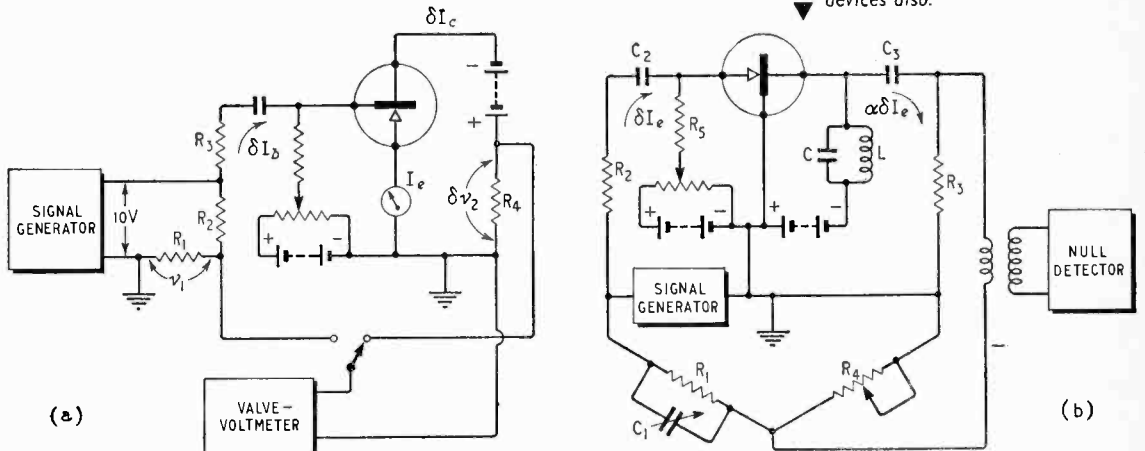

Fig. 9. Measurement of current gain (a) in the common-emitter mode and (b) in a bridge circuit which can be used for point contact devices also.



To make certain that exactly 10V is applied,  $R_1$  is made exactly one thousandth of  $R_2$ : thus when measuring voltage across  $R_1$  a reading  $v_1 = 1\text{mV}$  should be obtained. Any reasonable voltmeter impedance would have a negligible effect during measurement, as  $R_1$  could be as low as, say, ten ohms.

To measure  $\delta I_c$ , the voltmeter is switched over to resistor  $R_4$  and current  $\delta I_c$  would be calculated:—

$$\delta I_c = \delta v_2 / R_4$$

By the use of a 100- $\Omega$  precision resistor for  $R_4$  the result for  $\beta$  under such conditions will be given by  $\delta v_2(\text{mV})$ :—

$$\beta = \delta I_c / \delta I_b = (\delta v_2 / R_4) / (10 / R_3) = \delta v_2 R_3 / 10 R_4$$

$$R_3 = 10^6 \Omega \quad R_4 = 10^2 \Omega$$

$$\beta = 10^{-3} \delta v_2 \text{ volts} = \delta v_2 \text{ millivolts.}$$

It is worth mentioning that this method is not practical for transistors with  $\alpha > 1$  (point-contact transistors) as the open base circuit might cause instability. However the second method is useful for current gain measurements on any type of transistor (Fig. 9(b)). Here the signal generator supplies the emitter circuit and under conditions such that  $R_2 \gg r_e + r_b$  and  $R_3 \ll r_e$  the emitter current  $\delta I_e$  causes a collector current equal to  $\alpha \delta I_e$ , provided that:—

- (a) impedance of  $C_2 \ll R_2$
- (b) impedance of  $C_1 \ll R_3$
- (c) impedance of the antiresonant supply circuit  $LC \quad Z = L / (CR) \gg R_3$  and
- (d)  $R_2 \gg r_e$ .

$\delta I_e$  and  $\delta I_c$  would flow only through  $R_2$  and  $R_3$  respectively and the corresponding voltage drops will be  $\delta v_2$  and  $\delta v_3$ . The signal generator also supplies current to another pair of resistors  $R_1$  and  $R_4$  forming the second arm of the bridge. As currents  $\delta I_e$  and  $\delta I_c$  are almost in phase (with reference to the signal from the generator) the four resistors forming the bridge can be adjusted so that a voltage null appears across the diagonal of the bridge. The balance condition (detected by a sensitive null indicator) can be expressed by the relation:—

$$\frac{\delta v_2}{\delta v_3} = \frac{\delta I_c R_2}{R_3 \alpha \delta I_e} = \frac{R_1}{R_4}$$

Therefore  $\alpha$  would be defined as:—

$$\alpha = \frac{R_2 R_4}{R_3 R_1}$$

To ease the calculation, it can be arranged that  $R_2 = R_1$  and  $R_3 = 100 \Omega$ . Then  $\alpha = R_4 / R_3$  and would be read directly from the variable resistor  $R_4$  (a decade box, say) expressed by the resistance in ohms divided by 100, assuming that the balance condition of the detector is maintained. The small capacitor  $C_1$  is sometimes useful as an aid to obtaining a perfect null if there is a very small phase shift between  $\delta I_e$  and  $\alpha \delta I_c$ .

### Capacitance Measurement

The emitter-to-base and collector-to-base capacitance is important in h.f. transistors. These capacitances are of the order of picofarads and generally are dependent on the transistor's working point. Therefore the test frequency has to be chosen rather high (about 500kc/s) in order to reduce the reactances formed by these capacitances, so making the test voltages and currents small. This is necessary to avoid variation of capacitance during the cycles of the test voltage. For measurement of collector capacitance a substitution-bridge or Q-meter method might be employed.

A substitution bridge (see Fig. 10(a)) is an ordinary radio-frequency impedance bridge which has a facility for the connection of the transistor output circuit in parallel with the arm  $C_1 G_1$  (via switch S and capacitor C).

During measurement two operations have to be made: First, with switch S open, an initial balance should be obtained; values of  $R_1 R_2$  and  $G_1 G_2$  (the lower arms are calibrated in conductance terms) should be of the same order (and roughly equal to, say, 20–50k $\Omega$ ). Then readings of  $G_1$  and  $C_1$  should be noted.

By connection of the transistor circuit in parallel with  $C_1 G_1$  the now unbalanced bridge should be brought back to balance by resetting  $C_1 G_1$  to smaller values,  $C_1' G_1'$ . The collector capacitance

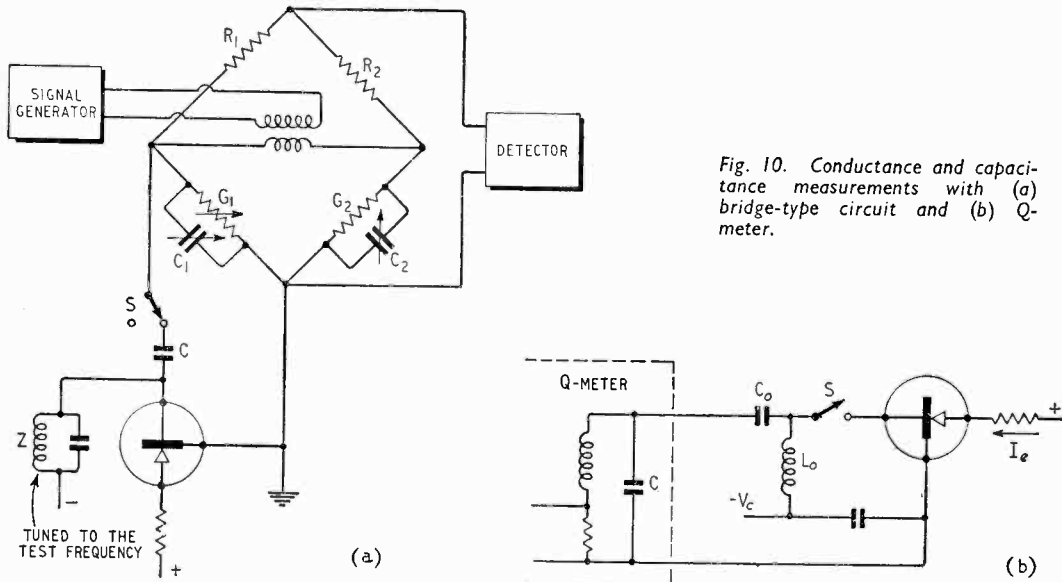

Fig. 10. Conductance and capacitance measurements with (a) bridge-type circuit and (b) Q-meter.

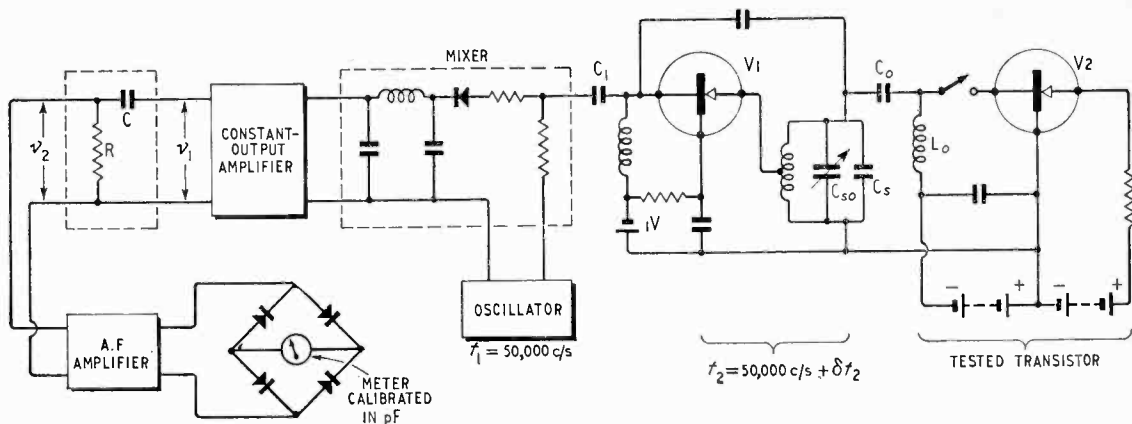

Fig. 11. Transistor capacitance test set. Here the tested transistor is added to a tuned circuit and the change in beat note registered.

$c_c$  and the output conductance  $g_c$  will now equal the increments:

$$c_c = C_1 - C_1' \quad g_c = G_1 - G_1'$$

Alternatively a Q-meter might be used for  $c_c$  and  $g_c$  measurement (Fig. 10(b)).

This is rather simpler and generally more accurate than the previous arrangement. The coupling capacitor  $C_0$  and the collector feed coil  $L_0$  is connected to the Q-meter's internal tuned circuit in the first instance (the transistor's collector is disconnected) and initial values of Q and C established (Q and C).

Next the collector circuit is connected (by switch S) and C has to be readjusted ( $C'$ ) to retain the Q-meter maximum indication and obtain a new value for Q ( $Q'$ ).

Again the value of transistor collector capacity can be computed from the increment:  $c_c = C - C'$  (read from the Q-meter's variable capacitor scale) and the value of output conductance  $g_c$  can be calculated from the Q readings:—

$$g_c = \frac{\omega C}{Q} - \frac{\omega C'}{Q'}$$

As we can see, the methods described above are useful if it is desired to know both  $r_c$  and  $g_c$ . Measurement of the former parameter has been treated previously and as we are concerned only with measurement of  $c_c$  it is worth mentioning a third practical method useful for production line tests for  $c_c$  (see Fig. 11).

Here a transistor oscillator (V1) working at a particularly low collector voltage feeds the transistor under test (V2) via conventional LC ( $L_0C_0$ ) coupling. By mixing the frequency  $f_1$  and the frequency  $f_2$  derived from another oscillator, a low-frequency beat note is obtained by detection. This beat note, after passing through a control amplifier arranged to give a constant-output sine wave  $v_1$ , is applied to the frequency-conscious circuit CR whose output  $v_2$  is proportional to the frequency of  $v_1$ . After amplification  $v_2$  is rectified and displayed on a meter directly calibrated in frequency.

For instance, by making the frequency-conscious circuit time constant 0.6msec ( $C = 0.006\text{mF}$  and  $R = 100\text{k}\Omega$ ), a linear response for  $v_2$  will be obtained for  $v_1$  within the range 0 — 250c/s.

Assuming that the frequency of both oscillators is

the same and equal to 50kc/s ( $f_1 - f_2 = 0$ ) and total capacity  $C_{s0} + C_s$  is 5000pF, by increasing  $C_{s0} + C_s$  by, say, 50pF, the beat-frequency note would change to 250c/s (50,000–49,750kc/s) which would give full-scale deflection of the output meter. In this way, the output meter scale could be calibrated directly in pF (non linear). In practice, more accurate results can be obtained if the initial beating note is chosen as, say, 10c/s instead of zero frequency and zero of measured capacity would correspond to some initial deflection.

When measuring the capacity of the transistor collector circuit, this initial deflection should be adjusted by setting  $C_{s0}$  with the collector disconnected ( $f_2 = 50,010\text{c/s}$ ,  $f_1 = 50,000\text{c/s}$ ). Then ( $f_2 = 50,010\text{c/s}$ ,  $f_1 = 50,000\text{c/s}$ ) after connecting the collector, a direct reading of capacity may be taken from the meter.

**Corrections.**—In Part 1 of this article (p. 372, July 1961) four lines below Equation 8, the list of increments should have read " $v_c v_c I_c \dots$ " and, on p. 374, the term given as  $r_c$  in Equation 24 should have been  $r_e$ .

## SEPTEMBER ISSUE

### Show Guide

Next month's issue, which will be on sale a week earlier than usual—on 22nd August (Preview Day), will contain a stand-by-stand guide to the Earls Court Radio Show together with a plan and list of exhibitors.

This will be in addition to the normal quota of pages devoted to regular features and technical articles covering topics of wide interest.

## OCTOBER ISSUE

### Show Reviews

In this issue the Technical Staff of *Wireless World* will give their impressions of the year's trends in sound and vision broadcast receivers as exemplified at Earls Court, and of aeronautical electronics as seen at Farnborough. There will also be reports on exhibitions in Germany, Holland and Denmark.

# Phase Difference Measurement

UNUSUAL METHOD USING A COUNTER

By R. B. C. COPSEY\*, A.M.I.E.E.

**I**N the design of audio amplifiers, filters, equalizers, transformers and similar equipment, the need often arises for an accurate measurement of phase difference between two sinusoidal voltages of the same frequency.

There are two basic ways of measuring phase differences in common use: one way makes use of a cathode ray-tube, and the other relies on voltage measurements on the combined signals. Both methods can be arranged to give direct readings in terms of phase difference, or, which is perhaps better, can be arranged to be null-reading in conjunction with a calibrated phase-shifting element.

**Cathode-Ray Tube Measurements.**—Probably the simplest way of measuring phase difference is to apply the voltages to be compared to the vertical

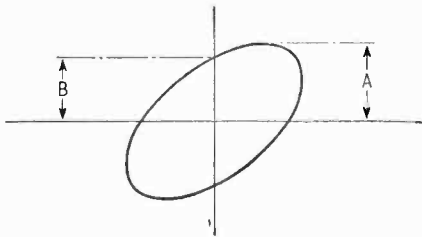

Fig. 1 Use of c.r.t. trace to measure phase difference.

deflector plates of a double-beam oscilloscope, and observe the phase difference. Provided that both voltages are of sufficient amplitude to obtain a reasonable vertical deflection, and the time base is reasonably linear, this method gives an accuracy which may be as good as  $\pm 10^\circ$ , or may well be far worse, depending on the skill and care of the operator. If one, or both, of the voltages to be compared is too small to obtain a reasonable deflection, then use of the vertical-deflection amplifiers may introduce errors due to the phase shifts in the amplifiers themselves. Any differential phase shift in these amplifiers can be readily checked by applying one signal to both inputs simultaneously and observing the relative phase of the two traces produced.

The more usual method of measuring phase difference with a cathode ray tube is to apply one voltage to the horizontal deflector plates, while the other is applied to the vertical deflector plates.† The resulting pattern will be elliptical (Fig. 1) and by measuring the heights A and B, the phase difference,  $\theta$ , may be calculated from the formula

$$\sin \theta = \pm \frac{B}{A}$$

Here again (except where the phase difference

is either  $0^\circ$  or  $180^\circ$ , resulting in a straight line) the accuracy of the result obtained depends very much on the skill and care of the operator.

The above methods may be improved considerably in accuracy by the use of a calibrated adjustable phase shifter, which is connected in series with one of the two voltages being compared, and adjusted so that zero (or  $180^\circ$ ) phase difference is obtained.

**Voltage Measurements.**—The method of calculating phase difference from measurements of voltages necessitates the use of a combining circuit in which the two voltages to be measured are added. A suitable circuit is shown in Fig. 2, in which two pentodes share a common anode load resistor. This resistor is made small in comparison with the anode impedance of the pentodes, so that variations of anode voltage due to the current in one valve have virtually no effect on the other valve's current. Three voltage measurements are necessary to determine the phase difference between the applied voltages:—

- (1)  $E_1$ , the output voltage when only one voltage is applied,
- (2)  $E_2$ , the output voltage when the other voltage is applied, and
- (3)  $E_3$ , the output voltage when both voltages are applied.

From these measurements, the phase difference  $\theta$  may be calculated from

$$\cos \theta = \frac{E_3^2 - (E_1^2 + E_2^2)}{2E_1E_2}$$

One of the limitations of this method of measuring phase differences is that it is not possible to determine the sign of the phase difference, i.e., which voltage leads (or lags) the other.

The accuracy of this method depends on the amount of phase difference involved, and it can be

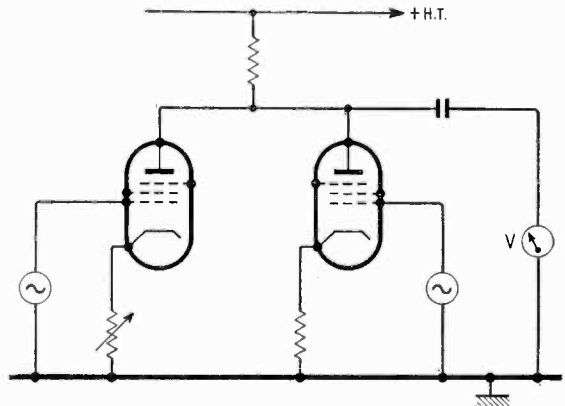

Fig. 2 Circuit for adding two voltages.

\*Redifon Ltd.

††"Electronic Measurements" by Terman and Pettit, second edition, p. 267 (McGraw-Hill).

seen from Fig. 3 that when  $\theta$  is small and  $E_3$  is almost equal to  $E_1$  plus  $E_2$ , it is impossible to achieve any real accuracy. It is also necessary that  $E_1$  and  $E_2$  should be similar in magnitude. One variation of this method involves the use of a calibrated adjustable phase shifter which is connected in series with one of the applied voltages. The phase difference is then measured by adjusting both the phase shifter and the gain of one of the pentodes until zero output voltage is obtained. Under this condition the two voltages present across the common anode load resistor are equal in amplitude but  $180^\circ$  out of phase, and the phase difference of the two voltages being measured may be read directly from the calibrated phase shifter.

Another variation of the voltage measuring method is perhaps worth mentioning. In this case the amplitudes of the two voltages under test are made accurately equal. This can obviously be

Fig. 3 Vector addition of two voltages.

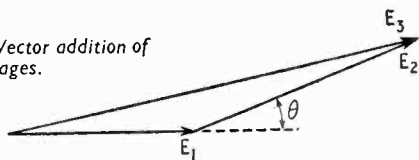

done by means of a variable attenuator and a voltmeter, or other suitable indicator. However, a more elegant method employs two separate amplifiers with effective automatic gain control. The two output voltages from these amplifiers can be made equal to any desired degree of accuracy. The above formula for the phase angle then reduces to

$$\cos \theta = \frac{E_3^2 - 2E_1^2}{2E_1^2}$$

where  $E_1 = E_2$   
i.e.  $\cos \theta = \frac{1}{2}r^2 - 1$

where  $r$  is the ratio of the voltages  $E_3/E_1$ . This ratio can be measured quite accurately by means of an indicator and a good, calibrated variable attenuator. The measurement of the phase angle is thus reduced to two equalizing operations and one measurement of voltage ratio.

None of these methods involving voltage measurements is particularly quick, and only the last two methods are capable of giving any real accuracy.

**A New Method.**—As far as the author is aware, it is not generally realized that phase differences can be measured easily and with a known accuracy by using a sinusoidal voltage source and an electronic counter.

Fig. 4 shows the set-up of the apparatus necessary to measure the phase delay of a network. The counter must be of the type in which it is possible to count the time interval between a "Start" and a "Stop" signal, and both the "Start" and "Stop" triggers must be capable of being switched to operate on either positive- or negative-going signals. Further, it is essential to the success of this method that both the triggers operate consistently at points on the sine waves which have the same amplitude (and polarity).

The counters available to the author do possess these features, though the same may not be true of all models. Most electronic counters have these facilities, and will count a time interval to an accu-

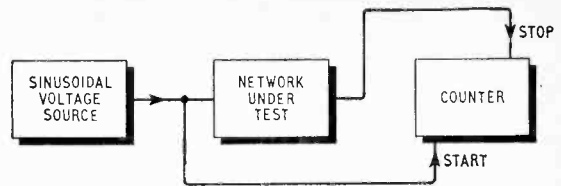

Fig. 4 Use of a counter to measure phase difference.

acy of  $1\mu\text{sec}$ . At least one counter on the market will count to an accuracy of  $0.1\mu\text{sec}$ .

The procedure for measuring phase differences is as follows. First, the counter is switched to count "Events per unit time", and the signal frequency source is adjusted accurately to the frequency at which the measurement is to be made. Next, the counter is switched to "Time Interval Measurement", with both the "Start" and "Stop" triggers switched to operate on, say, a positive-going voltage. As will become apparent later, the precise point at which the triggers operate is not important, and the amplitudes of the two voltages fed to the counter do not matter, provided that they are big enough to operate the triggers.

Referring to Fig. 5, let us assume that the input voltage has operated the "Start" trigger at point A. The counter will now count (usually at the rate of one million counts per second) until it is stopped at point B by the action of the "Stop" trigger. The counter will now register a count equal to the time  $T_1$ , which clearly does *not* equal  $T$ , the time delay between the two voltages. The trigger polarity switches are now reversed, so that the "Start" and "Stop" triggers operate on the negative-going voltage, and trigger at points A' where counting commences, and B' where counting ceases. The counter will now register a delay time  $T_2$ .

From Fig. 5,

$$T = T_1 - (a + b) \text{ and } T = T_2 + (a' + b')$$

Now the counter operates so that trigger points A and A' have the same amplitude (and polarity), and so do points B and B', though, of course, the

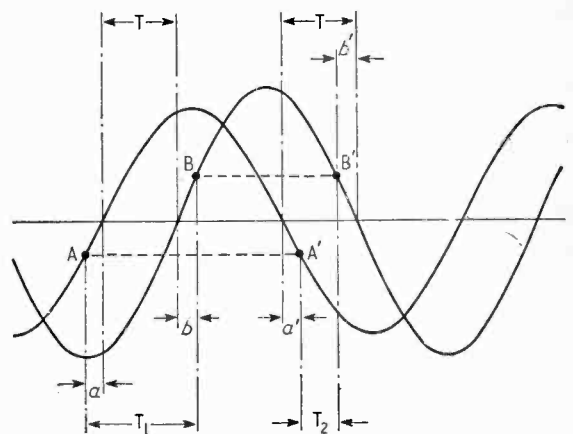

Fig. 5 "Start" and "stop" times using a counter to measure phase difference as in Fig. 4.

latter value is not necessarily equal to the former. Because of the symmetry of the sine wave this equality of amplitudes ensures the equality of time intervals  $a$  and  $a'$ , and again, the equality of  $b$  and  $b'$ . And so,

$$T = \frac{T_1 + T_2}{2}$$

The time delay can be readily turned into degrees, since a time delay  $T$  corresponds to a phase delay  $\theta$  of  $fT \times 360^\circ$  (with  $f$  in c/s and  $T$  in seconds).

It can be seen from the diagram that the average time delay  $T$  is unaffected by the amplitudes of the two voltages being compared, and is also unaffected by the actual levels and polarities at which the triggers operate.

This method of measurement is essentially one of measuring a time delay, and if this delay is measured to an accuracy of  $\pm 1\mu\text{sec}$ , at a frequency of 10,000c/s the accuracy would be  $\pm 3.6^\circ$ , and proportionately better at lower frequencies. A

10Mc/s counter, giving an accuracy of  $\pm 0.1\mu\text{sec}$  would of course give ten times greater accuracy, i.e.  $0.36^\circ$  at 10,000c/s. The great advantage of this method of measurement is that it calls for no special skill on behalf of the operator.

It will be appreciated that when measuring the phase shift of, say, a multi-section low-pass filter, the phase shift may exceed  $360^\circ$  as the cut-off frequency is approached. If a series of measurements is made, starting at a low frequency where the angular phase shift is small, there will be a point where the readings show phase differences approaching  $360^\circ$ , and suddenly change to a few degrees. In this case the actual phase shift is  $360^\circ$  plus the reading obtained.

In conclusion, it is worth pointing out that circuits which are usually regarded as giving a phase advance, will of course be measured as a time delay, so that a circuit designed to give, say, a phase advance of  $45^\circ$  will be measured as giving a delay of  $360^\circ - 45^\circ = 315^\circ$ .

## BOOKS RECEIVED

**Thyratrons**, by C. M. Swenne. An introduction to thyratrons intended to inform the mechanical and control engineer of the advantages which these devices may have over the more familiar mechanical alternatives. Describes the basic principles and operating characteristics, with some descriptions of circuit techniques. A chapter is devoted to applications and an appendix gives data for some eighteen types. Pp. 82; Figs. 68. Philips' Technical Library. Obtainable from Cleaver Hume Press, Ltd., 31, Wright's Lane, Kensington, London, W.8. Price 12s 6d.

**Digital Computers and Counters** by E. Bukstein. Intended for junior engineers and technically minded laymen, the book presents a simple, non-mathematical exposition of digital computing and counting techniques. Having described the operation of electronic circuitry relevant to the subject, the author goes on to discuss the logical principles involved and methods of information storage, control systems and input/output equipment. A chapter deals with digital and analogue encoding and decoding, and an appendix contains descriptions of commercially available packaged computing circuits. Pp. 248; Figs. 223. Rinehart and Company, Inc., 232 Madison Avenue, New York 16, N.Y., U.S.A. Price \$7.00.

**Radio and Electronics**, edited by J. H. Reyner. The work of 23 contributors, this two-volume work is intended for the student and junior engineer, and covers a broad field. The first volume is concerned chiefly with the theory of circuit elements and modulation systems, with a chapter on mathematics. In the second volume, the emphasis is on the application of these principles, and the subjects covered include radio transmission and reception, audio engineering, radar, and industrial and medical electronics. The work is well illustrated and indexed. Vol. 1. Pp. 548, Vol. 2. Pp. 494. Sir Isaac Pitman and Sons, Ltd., Pitman House, Parker Street, Kingsway, London, W.C.2. Price £5 per set.

**Television Receiver Servicing. Vol. 1: Time-Base Circuits**, by E. A. W. Spreadbury. This is the second edition of an introduction to television receiver servicing for the man who is experienced in the repair of sound radio equipment. The book has been revised to bring it completely up to date and includes descriptions of  $110^\circ$  c.r.t. operation, third-harmonic tuning of the line

output transformer and many of the latest developments in television circuitry. The first volume deals exclusively with time-base and associated circuits, and all facets of servicing in these sections of the receiver are dealt with in an essentially practical manner. E.h.t. circuits and tube operation are discussed, and the final chapter contains advice on the selection and use of test equipment. Pp. 364; figs. 214. Iliffe Books, Ltd., Dorset House, Stamford Street, London, S.E.1. Price 25s (25s 6d by post).

**Principles of Feedback Control**, by C. H. Wills. An exposition of analytical methods of feedback system design. The book is intended for the graduate or the practising engineer, and it is assumed that the reader is familiar with differential equations and complex-variable theory. Stability is the main problem discussed, with equal attention paid to the frequency-response and root-locus methods of solution. Pp. 271; figs. 146. Addison-Wesley Publishing Co., Inc., 10-15, Chitty Street, London, W.1. Price 66s.

**Pratique Electronique** by J.-P. Oemichen. A systematic approach to the design of electronic equipment. In three parts, the book deals first with input transducers, in the widest terms. It then treats very fully the design of basic circuits, with reliability the chief goal. The author assumes knowledge of the operating principles of circuits described, and confines his treatment to the evaluation of circuit elements and operating limits. The third part of the book is a discussion of "system planning." Starting with a specification, the author explains the method of arriving at a principle of operation of the complete equipment. Examples of design procedures are given to illustrate methods proposed. The bibliography is extensive. Pp. 304; Figs. 162. Editions Radio, 9, Rue Jacob, Paris 6<sup>e</sup>. 1485F by post.

**Basic Ultrasonics**, by Cyrus Glickstein. The "picture book" approach is adopted in this appraisal of the fundamentals of ultrasonics engineering. Like Gaul, the book is divided into three parts. The first deals with the general theory of sound waves, while the basic types of equipment are discussed in the second section. Detailed descriptions of applications are then given, with an indication of possible future developments in this field. Pp. 137; well-illustrated. John F. Rider, Publisher, Inc., 116, West 14th Street, New York 11, N.Y. Price \$3.50.



# LETTERS TO THE EDITOR

The Editor does not necessarily endorse the opinions expressed by his correspondents

## Colour Tube Costs

THOSE who are worried about the alleged high cost of a colour picture tube will get little comfort from the figures in Donald Macphail's letter (July issue, p. 369). It may be very creditable for R.C.A. to have got the wholesale price of their tubes down to £40-£50, but this is still far too high for British pockets.

To illustrate this, here are two bits of arithmetic. The first takes the most optimistic view of the situation:

Price of colour tube (500 off) .....	£40
Price of 21in monochrome tube (retail) .....	£14

Difference .....

£26

Now, £26 may be a trifling sum to Mr. Macphail, but it is rather more than two weeks' wages to the average Briton.

The second bit of arithmetic is more realistic. It is well known in the trade that the retail price of a picture tube is 2-3 times the price paid by setmakers. Taking the more favourable limit, we have:

Cost of colour tube to viewer .....	£80
Cost of 21in monochrome tube .....	£14

Difference .....

£66

I, too, would like colour television, but as an addition to eating, not an alternative.

R. WAREHAM

## Series and Parallel Feedback

IN the March issue the author of "Accurate Record Equalizer" (page 121) discussed two types of feedback amplifier, one using parallel and the other series voltage feedback. The author dismissed the first configuration as unsuitable since he deduced from the relationship  $AY_1 \gg Y_1 + Y_2 + Y_{in}$  that the input impedance  $R_{in}$  of the amplifier would need to be so high than an emitter follower would have to be used for its input stage. Assuming that a two-stage amplifier were to be used, this meant that only one stage would be available for voltage amplification.

We have successfully designed and built many transistorized amplifiers using parallel voltage feedback and we shall show in the following analysis that if the closed-loop gain is to be  $Z_1/Z_2$  then  $R_{in}$  should be less than a value which will be deduced. No conclusions about the value of  $R_{in}$  can be drawn directly from the above relationship since the open-loop gain  $A$  is dependent on  $R_{in}$ . It is necessary, therefore, to find first an expression for  $A$  involving  $R_{in}$ .

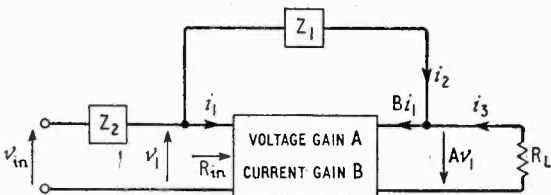

In Fig. 1

$$A = \frac{i_3 R_L}{v_1} \quad \dots \quad (i)$$

$$i_3 = B i_1 - i_2 \quad \dots \quad (ii)$$

$$i_2 = \frac{v_1 (1 + A)}{Z_1} \quad \dots \quad (iii)$$

$$i_1 = \frac{v_1}{R_{in}} \quad \dots \quad (iv)$$

Substituting (iii) and (iv) into (ii) gives:

$$i_3 = v_1 \left\{ \frac{B}{R_{in}} - \frac{(1 + A)}{Z_1} \right\} \quad \dots \quad (v)$$

Then, substituting (v) into (i) we have:

$$A = \frac{R_L (B Z_1 - R_{in})}{R_{in} (Z_1 + R_L)} \quad \dots \quad (vi)$$

The condition for the closed-loop gain to be  $Z_1/Z_2$  can be written:

$$\frac{A}{Z_1} \geq \frac{1}{Z_1} + \frac{1}{Z_2} + \frac{1}{R_{in}} \quad \dots \quad (vii)$$

Substituting (vi) into (vii) and rearranging, gives the final condition that:

$$R_{in} \leq \frac{Z_1 [R_L (B - 1) - Z_1]}{Z_1 + 2R_L + Z_1 (Z_1 + R_L)}$$

Finally, we should point out the different conditions when using transistors or thermionic valves for amplifiers employing this type of feedback. In the transistor case, the output voltage is dependent on the mutual resistance of the amplifier and hence, maximum open-loop voltage gain is obtained for minimum input impedance (ignoring shunting effect of any bias network, of course). In the case of valve amplifiers, however, it is the input voltage which controls the output voltage so therefore the input impedance should be as high as possible, since any input current is merely a drain from the virtual earth point and serves no useful purpose.

J. W. KING,  
P. K. WARRICK

Heston, Middlesex.

The author replies:

With regard to the comments of Messrs. J. W. King and P. K. Warrick, I should like to point out that my statement that the input resistance of the amplifier should be high, was meant to imply that for amplifiers with gain  $A$  the one with the highest input resistance would introduce least inaccuracy into the closed loop gain. This is clearly true.

An analysis is given by Messrs. King and Warrick which shows that the input resistance should be very low, but if it is reduced, either artificially by shunting elements, or by replacing a c.e. or c.c. stage by a c.b. stage, then in each case the current gain  $B$ , is reduced. Thus their conclusion is not as sweeping as it at first may seem. In fact, they are proving that for amplifiers with current gain  $B$ , and with given output resistance, the one having the lowest input resistance gives the greatest accuracy of definition of closed-loop gain. Compare this with my statement that for amplifiers of voltage gain  $A$ , and with given output resistance, the one having the highest input resistance gives the greatest accuracy of definition of closed-loop gain. Both statements are true, but it must be remembered that increased current gain does not always go hand in hand with reduced input resistance, and increased voltage gain does not always go hand in hand with increased input resistance.

It is also worthwhile pointing out that the output resistance has an effect on the accuracy of definition of closed-loop gain. A simple analysis shows the truth of the following statements: for amplifiers of voltage gain  $A$ , and of given input resistance, the one having the lowest output resistance has the best closed-loop accuracy; and for amplifiers of current gain  $B$ , and of given input resistance, the one having the highest output resistance has the best closed-loop accuracy. In practice, different

amplifiers will have differing input resistances, output resistances, voltage gains, and current gains, so that different configurations can fairly be compared only when all the above parameters are taken into account. (Note that any three of the parameters specify the other.)

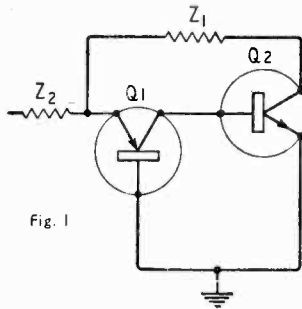

Fig. 1

resistance, which is easily seen to if each transistor has a current gain of  $\beta$ . The output resistance of the first is a little lower than that of the second, both being of the order of  $5k\Omega$ , so for purposes of comparison we shall neglect output resistance in each case.

The current gain of the first amplifier is  $\beta$ , and of the second amplifier  $\beta^2$ . The voltage gains can be calculated (assuming zero output resistance) and are  $Z_1\beta/R_{in}$  and  $Z_1/R_{in}$  respectively.

A measure of the accuracy of a given closed-loop system is

$$D = \frac{AY_1}{Y_1 + Y_2 + Y_{in}}$$

the higher this quantity, the greater being the accuracy.

For Fig. 1.

$$D_1 = \frac{Z_1\beta Y_1/R_{in}}{Y_1 + Y_2 + Y_{in}} = \frac{\beta K}{Y_1 + Y_2 + Y_{in}}$$

For Fig. 2.

$$D_2 = \frac{Z_1\beta^2 Y_1/R_{in}}{\beta^2(Y_1 + Y_2) + Y_{in}} = \frac{\beta^2 K}{\beta^2(Y_1 + Y_2) + Y_{in}}$$

where  $\beta \gg 1$  and  $K = Z_1 Y_1/R_{in}$

There are now three cases to consider:—

(1)  $Y_1 + Y_2 \gg Y_{in}$

Then  $D_1 \approx \frac{\beta K}{Y_1 + Y_2}$  and  $D_2 \approx \frac{K}{Y_1 + Y_2}$  and  $D_1 \gg D_2$ .

(2)  $\beta^2(Y_1 + Y_2) \gg Y_{in} \gg Y_1 + Y_2$

Then  $D_1 \approx \frac{\beta K}{Y_{in}}$  and  $D_2 \approx \frac{K}{Y_1 + Y_2}$  and  $D_1 > D_2$  depending as  $Y_{in} \leq \beta(Y_1 + Y_2)$ .

(3)  $Y_{in} \gg \beta^2(Y_1 + Y_2)$

Then  $D_1 \approx \frac{\beta K}{Y_{in}}$  and  $D_2 \approx \frac{\beta^2 K}{Y_{in}}$  and  $D_2 > D_1$ .

It would therefore seem that in this practical example (which is perhaps typical of attempts to reduce, or increase, the input resistance) the relative merits of the two systems depends not only upon  $R_{in}$ , but also upon the magnitude of  $R_{in}$  compared with the magnitudes of  $Z_1$  and  $Z_2$ .

The above simple example shows the danger of making general statements such as I did about increasing the input resistance, and as Messrs. King and Warrick did about reducing the input resistance.

Having made the above point, I would agree that I should not have dismissed parallel feedback for the reasons stated. Results just as good, possibly better, can be obtained with parallel feedback around a c.c. stage followed by a c.c. stage.

In conclusion, I should like to thank Messrs. J. W. King and P. K. Warrick for their comments, which were most illuminating, and, for me at least, shed new light on the subject.

T. M. A. LEWIS

### Museum Pieces

CONGRATULATIONS to John Munning (July issue). He has the full backing of scores of engineers if they are worthy of the name. How well I remember the receivers of which he writes, and how well large numbers of those sets still function today.

What are the designers of our leading manufacturers paid for today, skimping? In a leading make of the latest radio they have the audacity to anchor the dial cord in a slotted nylon boss (the centre of the drive drum), with a dab of glue. The drive cord is spring loaded, the dab of glue lasts a few days and the customer angrily returns the set. What was wrong with the metal tag retaining system. I have had three new models returned in a matter of weeks with this and other troubles. To get that cord to stay on again wastes engineers' valuable time when their knowledge should be directed to more technical difficulties. Is the trade full of apprentices with nothing better to do? Do the manufacturers think these things will keep them busy? And those plastic pulley wheels, BAH!

Customers are getting fed up with shoddy stuff. They want to know why it has broken down so soon. I open the back and show them the inside but they have no other choice; the sets are all much the same. Yet it is time the public knew what could be theirs if only they would look beyond the glitter and then refuse to buy. If you discuss these shortcomings with the firms' representatives they only reply "It's what the public wants." It is high time that craftsmanship in the above fields returned once more to restore the name of which Britain once was proud.

W. A. MILLS

Cross Gates, Radnorshire.

### L'inénarrable Free Grid

"FREE GRID" appeals to Francophilologists to explain Monsieur Aisberg's compliment in calling him "l'inénarrable Free Grid." Without in the least aspiring to such a lofty title as Francophilologist, I think I can supply the answer.

First of all, however, I refuse to consider it to be anything but a compliment. Monsieur Aisberg is a very nice man, who would not think of soiling a whole page of congratulations with a qualification even remotely suggesting "unspeakable" to indicate a member of your "vaillante équipe."

In the French word "inénarrable" you will recognize the English word "narrate." It means something which cannot be related or recounted in any other form or version. As a matter of fact, Free Grid's "Unbiased" can only be cited verbatim. Any change will completely spoil the effect and, above all, translation is impossible.

Monsieur Aisberg must indeed possess a first-class knowledge of colloquial English, and above all have a true appreciation of the English character, an appreciation which we Dutchmen believe we possess, but in our pride consider quite exceptional in other people.

Of course, Free Grid knows quite well what it is all about, but he is up to his well-known and well-appreciated tricks.

This, however, is the season of green herring, not of the red kind.

A. J. VAN GILSE

Köln-Nippes, Germany.

# AUTOMATIC DOOR

BATTERY-POWERED TRANSISTOR

PROXIMITY SWITCH

By A. J. HENK

*To those who may accuse us of frivolity in giving space to this article we make no apology, for the principles and practical details of the proximity switch described will be useful in a variety of applications.—Editor.*



**T**HAT lovable animal the domestic “alley cat”—a remarkably independent creature—asks but little in the way of routine attentions. To grant a cat complete freedom to come and go at will raises problems: a window permanently open has a fascination for burglars and the icy winter winds; holes in a door, even with a hinged flap, admit howling gales, rain and snow in the winter, wasps and midges in the summer and dirt all the year round. Electronics, however, can come to the rescue with an “automatic” door.

## Design Considerations

A convenient way for the cats to enter and leave the house is through an opening in the back door. This exit should be closed when not in use and it must be possible for a cat to cause it to open by doing little more than merely wanting to go out. It must also operate when the cat wishes to enter the house from without.

The safety of such a device is obviously of great importance, particularly since it may be left unattended for long periods, so it was considered inadvisable to use a.c. mains to supply the necessary power. Battery operation was therefore employed and for reasons of economy the electronic circuitry was transistorized. A cat cannot be expected to operate contacts or manipulate switches so the device was designed to work on a proximity basis: the natural way for a cat to indicate a wish to go out is to sit near the door. The equipment must operate for 24 hours a day and this emphasizes the need for a design of economical power consumption. Finally, a high degree of reliability must be maintained as, when a cat is used to being able to go out when necessary, an equipment failure can result in unfortunate consequences.

An obvious proximity detector is a light beam and

photocell which, by a system of mirrors or duplication, can be made to operate on both sides of the door. A break in the light path can cause a relay to start a small electric motor lifting a vertical sliding panel covering the opening in the door. Such a system has the advantages of simplicity and stability but, as a torch bulb of sufficient intensity consumes about 300mA the battery would require changing every few hours. Furthermore the life of such a bulb is limited and the sudden failure of the system from this cause would be difficult to anticipate. A system relying on capacitance changes is much more attractive for, although sensitive electronic circuitry would be necessary, battery current drain could be kept low under quiescent conditions and the long life of transistors would ensure good reliability.

The system finally evolved uses the presence of the cat to alter the capacitance between two electrodes and unbalance an a.c. bridge fed from an oscillator running at about 5kc/s. The unbalance voltage is amplified and rectified, the resultant d.c. being used to operate the motor relay. By simply extending the sensing electrodes on both sides of the door the system can accommodate two-way traffic without any duplication of circuitry. The panel is raised in vertical guides by a small electric motor operating through a system of gears and pulleys, and returns under gravity to close the opening when the relay releases.

## Circuit Details

Fig. 1 is the circuit which was developed to meet all the above requirements and certain others subsequently encountered. V1 is an oscillator operating at about 5kc/s giving a two-phase output, and L<sub>1</sub> is chosen to resonate with C<sub>2</sub> and C<sub>3</sub> in series at this frequency: a value of 20mH has been found satisfactory, wound on a Ferroxcube pot core. C<sub>2</sub> and C<sub>3</sub> also form two of the arms of the bridge, which

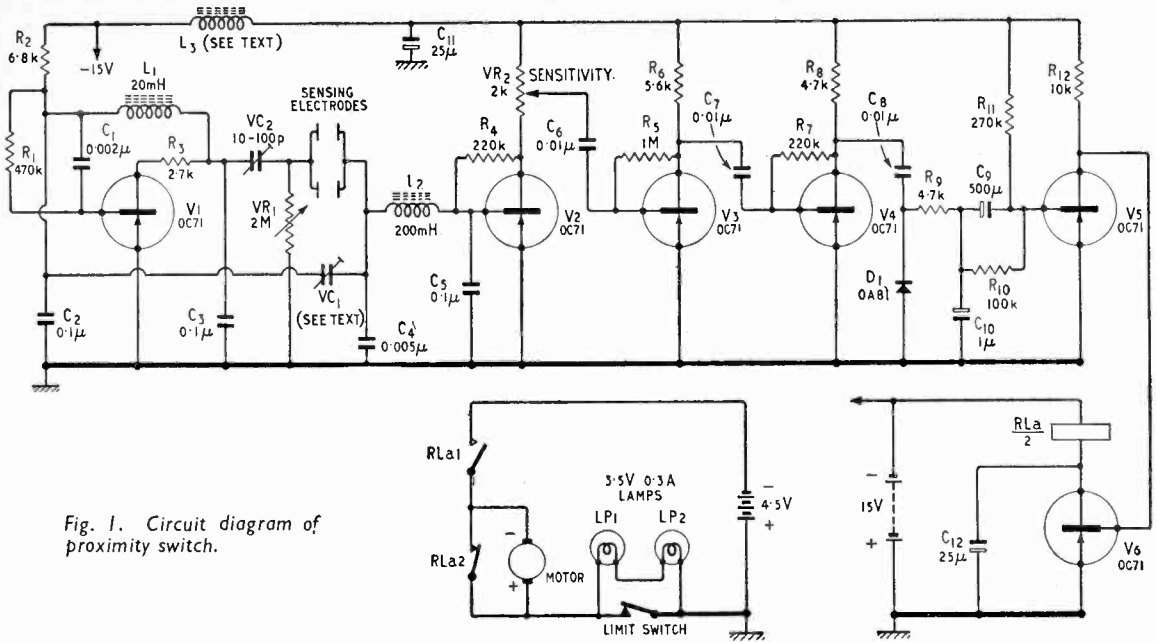

Fig. 1. Circuit diagram of proximity switch.

has been redrawn in Fig. 2. With equal values of  $C_2$  and  $C_3$  the bridge will balance when the value of  $VC_1$  is equal to the capacitance  $C_9$  between the sensing electrodes, about 1 or 2pF. The required capacitance of the "visible" part of the component  $VC_1$  may well be lower than this, being supplemented by wiring strays. Difficulty was encountered in obtaining a trimmer of sufficiently low capacitance and the most satisfactory system was found to be a pair of short wires twisted together for a few millimetres. Stray wiring capacitance was also responsible for a further effect which resulted in an exact balance with a precise null point being unobtainable. The introduction of a small adjustable phase shift in one of the arms of the bridge by means of  $VR_1$  and  $VC_2$  counteracted this effect satisfactorily. The size and shape of the sensing electrodes can be seen from Fig. 4. There is an identical pair on the other side of the door, the two pairs being connected in parallel.

The bridge output terminal is clearly a very high impedance point and some form of matching is essential if a transistor amplifier is to be used. This is the function of  $L_2$  wound on a Ferroxcube pot core and resonated at the oscillator frequency by  $C_4$  and  $C_5$  in series. The base of  $V_2$  is fed from a suitable low-impedance point in the matching network.  $V_2$ ,  $V_3$  and  $V_4$  are used in a largely conventional amplifier, raising the very low bridge output signal to a suitable level for rectification. A measure of thermal stabilization is achieved by returning the base bias resistor of each stage to its collector. A small change in working point with temperature is unimportant since even at the collector of  $V_4$  the signal amplitude is only a volt or so. Rectification of the signal takes place at the cathode of  $D_1$  (a general purpose semiconductor diode) and after smoothing by  $C_{10}$  the positive direct voltage is fed to the base of  $V_5$  via  $C_9$ . The value of  $C_9$  is chosen to give a long coupling time-constant such that any rise in the bridge output applies positive bias to the base of  $V_5$ , cutting off its collector current. Under quiescent conditions sufficient bias current

flows into  $V_5$  from  $R_{11}$  to cause its collector to bottom, and in this state there is insufficient voltage at the collector to cause  $V_6$  to pass current. When  $V_5$  is cut off, however, the base of  $V_6$  will pass 1.5mA from  $R_{12}$  and this is sufficient to bottom this stage so that almost the whole of the battery voltage is applied across  $RL_a$ . This method of relay operation ensures that the contacts will close very positively when the input to  $V_5$  exceeds a certain positive voltage, about 500mV, and the margin of voltage change over which the relay energizing current changes from zero to maximum is very small.

**Coupling Time-Constant.**—The introduction of an a.c. coupling ( $C_9$ ) into a "d.c." amplifier calls for further comment. This component was added after the installation had been in service for some time to meet an unforeseen circumstance. The life of the battery which energized the motor was found to be unexpectedly short; in fact, on several occasions a battery replaced during an evening was found to be almost completely exhausted the following morning. Further investigation revealed that the writer's cats were in the habit of sitting

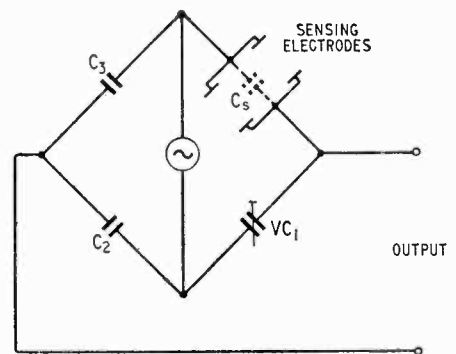

Fig. 2. Basic bridge circuit redrawn from Fig. 1.

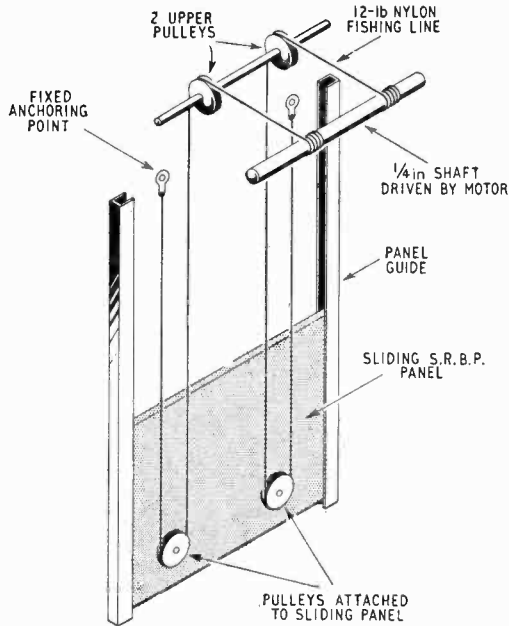

Fig. 3. Arrangement of cords and pulleys.

between the electrodes, opening the panel and surveying the garden from their sheltered vantage point for long periods at a time. During this time the motor was passing current and naturally the battery rapidly discharged. The addition of  $C_9$  allows the relay to remain operated only for as long as this capacitor takes to recharge to the voltage delivered by  $D_1$ —usually about 10-15 sec. After this period has elapsed the base of  $V_5$  is no longer positive and current can once more flow into it, thus the relay releases and the panel closes. When the cat gets fed up with staring at a closed door and goes away  $C_9$  takes about 20-30 sec to discharge into  $R_{10}$ ,  $R_{11}$  and the now low-impedance base-emitter junction of  $V_5$ , after which period the panel can be reopened in the usual way. The addition of  $C_9$  brings with it another important advantage, that of stabilizing the device against gradual changes in the bridge balance point. A critical balance can easily be disturbed by temperature or humidity changes or snow and frost, particularly if any snow or ice crystals form on the surface of the insulation supporting the outside pair of sensing electrodes. This effect was found to be quite troublesome at first, requiring very careful adjustment of the bridge balance and sensitivity controls if satisfactory operation was to be achieved. Re-adjustment was required at fairly frequent intervals as the battery voltage changed and also if there was a considerable change in weather conditions.  $C_9$  introduces sufficient attenuation at very low frequencies to prevent the device operating on signals (due to drifting) which build up very slowly compared with the rate of signal build-up during a normal operation. The gain of the 5-kc/s amplifier can now be increased to maximum by adjustment of the sensitivity control  $VR_2$  and the residual signal will merely charge  $C_9$  to a new steady value. Very small changes in balance will now be communicated to the base of  $V_5$  provided that they occur in a sufficiently short time

(1 to 2 sec) and a large increase in sensitivity is realized.

The purpose of  $L_3$  is to decouple the 5-kc/s amplifier from any oscillator voltage which  $V_1$  introduces onto the negative supply rail. As  $L_3$  works in conjunction with the large capacitor  $C_{11}$  a large inductance is not required and about 150 turns of 40 s.w.g. enamelled-copper wire wound on a  $\frac{3}{8}$  in dia dust core has been found ample. This component is in no way critical.

Low-power a.f. transistors are used throughout, Mullard OC71 or S.T.C. TS2 being suitable types. Rather higher sensitivity can be achieved by using Mullard OC75 or S.T.C. TS3 for  $V_2$ ,  $V_3$  and  $V_4$ , or by selecting units with a high forward current-gain ( $>50$  at 5mA collector current) for these stages. The relay is a Type 3000 unit with a 500- $\Omega$  winding and consumes about 30mA when operated. The complete amplifier, oscillator and relay unit draws 10mA from the 15-V battery when quiescent and 40mA when the relay is operated.

### Mechanical Details

Details of the arrangement of the winding mechanism can perhaps best be obtained from Fig. 3 and the photograph showing the device with the covers removed. The motor which drives this mechanism is a 3- to 6-V d.c. permanent-magnet-field model motor made by Ever-Ready. This consumes about 750mA from the 4 $\frac{1}{2}$ -V supply when raising the panel and well over one ampere when stalled. In order to limit the stall current when the panel reaches the top of its travel a limit switch (actually a pair of

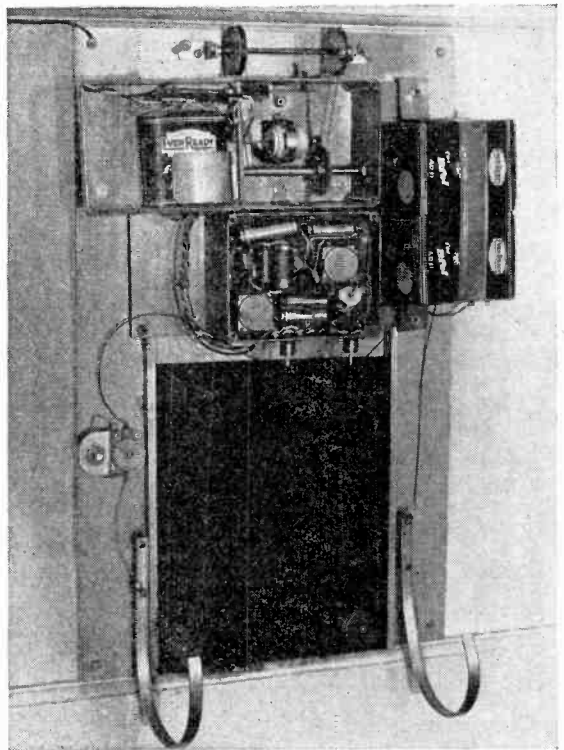

Fig. 4. Proximity switch and door-panel with covers removed.

contacts obtained from a Type 3000 relay) opens, introducing a limiting resistance in series with the supply. A suitable resistance is formed by two 3.5-V 0.3-A torch bulbs,  $LP_1$  and  $LP_2$ , connected in series to allow 200mA to flow into the stalled motor, this being sufficient to maintain the panel in its raised position. On the release of  $RL_a$ , the panel falls under gravity and to prevent its descending too rapidly the motor windings are short-circuited by a pair of back contacts on  $RL_a$  to introduce dynamic braking. The motor drives a  $\frac{1}{4}$ -in diameter shaft via a 4-to-1 reduction gear and winds two lengths of 12-lb nylon fishing line onto the shaft. A further 2-to-1 reduction is achieved by passing each cord over a pulley on the sliding panel and attaching the end to a fixed anchoring point on the upper part of the framework.

The panel itself is of synthetic-resin-bonded paper and measures  $7\frac{1}{4} \times 9\frac{1}{2}$  in. An aluminium panel was tried in the first instance but its position was found to affect the balance of the bridge, hence a non-conductor is required for this component.

As can be seen from Fig. 4 the winding mechanism is mounted in a box at the top of the device; a similar box immediately below this houses the oscillator, amplifier and relay. The sliding panel, when raised, occupies the space (about  $\frac{1}{2}$  in) between the two boxes and the front plate onto which the device is built. This is of 16-s.w.g. aluminium measuring  $19\frac{1}{2} \times 12$  in and is held onto the door by a 4-B.A. nut and screw at each corner. The side of the aluminium plate adjacent to the door is covered with foam plastic to exclude draughts.

### Batteries

The power supply for the amplifier consists of two  $7\frac{1}{2}$ -V batteries in series (Vidor L5042 or Ever-Ready AD31) mounted on the front panel by means of a springy brass strap. The low quiescent current drain of 10mA enables a useful life of about two weeks continuous running to be obtained from a set of batteries. The motor is driven by a  $4\frac{1}{2}$ -V torch battery mounted in the lid of the motor box, and its life is entirely dependent upon the frequency with which the unit is operated. If very frequent operation is required a more economical battery for this purpose is the larger  $4\frac{1}{2}$ -V "bell" battery, Ever-Ready type 126, which requires less depolarizing time between operations.

### Setting Up

An earth connection greatly facilitates this operation as well as being desirable when the unit is in service. A convenient method of setting up has been found in the connection of a 2-mA (or so) f.s.d. meter between the collector of V5 and the positive supply rail, and the short-circuiting of  $C_9$ ;  $VC_2$  is set at maximum capacitance and  $VR_1$  at maximum resistance. With the sensitivity control  $VR_2$  set to minimum V5 bottoms and only a small current flows into the meter. The precise amount varies with the meter resistance since the collector of V5 is a low impedance point but about 0.5mA appears typical. The presence of a signal on the cathode of  $D_1$  causes V5 to draw less collector current and, with this stage cut off, 1.5mA will flow into the meter. As the sensitivity control is advanced a little at a time  $VC_1$  can be set for minimum meter

deflection. As the sensitivity increases it may be found necessary to adjust  $VR_1$  and possibly  $VC_2$  to obtain a precise balance. At high settings of  $VR_2$  it may well be impossible to obtain complete cancellation by further adjustment, in which case it should be possible to obtain large meter deflections by inserting the operator's hand between the sensing electrodes. On disconnecting the meter, this latter test should cause  $RL_a$  to operate and then to release as soon as the hand is withdrawn.  $C_9$  may now be brought back into circuit and the  $VR_2$  further advanced if necessary. This may operate  $RL_a$  which should subsequently release when  $C_9$  is charged. The final setting up should be carried out with the device *in situ*, and after an initial settling-down period very little further attention should be found necessary apart from routine battery changes and an occasional drop of oil. When the 15-V supply falls as the batteries near exhaustion it may be of assistance to advance  $VR_2$  further if the amplifier sensitivity falls off before the supply voltage becomes insufficient to operate  $RL_a$ .

### Conclusion

This automatic door has been in continuous operation for three months at the time of writing and is of great value to the writer's feline family. There were no training problems; the natural curiosity of the animals soon taught them the purpose of the offending appendage and frequent use followed quickly. A friendly cat from across the way also knows how to use it, and a surprising demonstration of the usefulness of the device has been the appearance of postal packets on the kitchen floor, packets too large for even the most considerate of cats to bring in!

## Transistor Radio Set

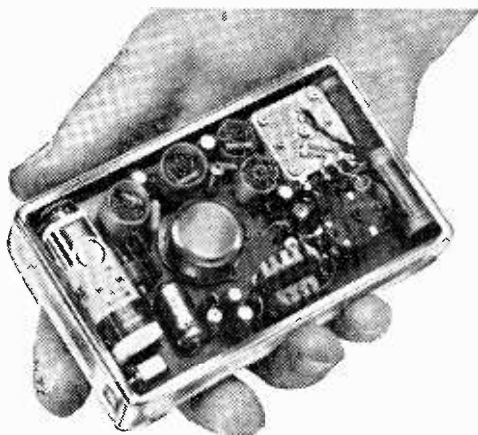

Shown in the photograph is an interior view of the new Fidelity Radio "Coronet" transistor set. This covers both the medium waveband and the Light Programme on long waves. It features a socket for private earphone listening or tape recording, two i.f. stages, and a 90mW push-pull output. It costs  $9\frac{1}{2}$  guineas.

# Components and Materials

CURRENT PRACTICE AND NEW DEVELOPMENTS DISCUSSED AT THE I.E.E.

**M**ICROMINIATURE components and reliability were the topics that were in the forefront of discussion at the conference. Packing densities of the order of  $10^5$  components per cubic foot and even greater are spectacular achievements in the former sphere of endeavour, while the requirements of submerged cable repeaters are responsible for the working life of twenty years which is becoming a common specification. The two requirements are not particularly compatible, and at the present state of the art, the only comment to be offered on the use of micro-miniature circuitry for reliability is, as K. E. Latimer remarked in his *rapportage*, "Don't."

On the subject of reliability, G. W. A. Dummer misquoted Sir Winston to the effect that never had so many spoken so much with so few results. After all the work that had been done in the subject, very few manufacturers are quoting estimated working lives. In the absence of catastrophic breakdown, the problem, of course, is to decide at what point in its decline a component can be said to have failed. One speaker pleaded for the craftsman approach to component manufacture, with what he described as the "cathedral atmosphere" in factories. The importance of reliability in submerged repeaters was illustrated by A. A. New, who drew attention to the fact that the cost of replacing a repeater would be in the region of £100,000. In a paper by N. B. Griffin, some evidence to bring blushes to the faces of electronic engineers was presented. Out of all the component parts of a guided missile, electrical components were responsible for 86% of failures, 69% being electronic. Breaking this down further, the highest number of electronic failures were due to wiring and joints (19%), with thermionic valves coming second at 15%. Capacitors and resistors were the most reliable with a failure rate of 3%.

The paper by D. I. Gaffee was an excellent introduction to the types of micro-miniature circuit, the problems involved and some solutions. The three types, micromodules, microcircuits and solid or solid-state circuits were described, and the design of a microcircuit equipment was discussed. The microcircuit consists of a glass or ceramic substrate on which are deposited the passive circuit elements and interconnections; the active components are either attached to the surface or are set into holes. The solid-circuit is formed from a single piece of semiconductor material which is doped and etched to obtain the required operation. The solid-circuit is, as yet, not much more than an interesting possibility, although much work is being done to develop it.

In discussion it was agreed that close co-operation will be needed between circuit designers, component designers, chemical engineers and thin-film physicists. The remark was also made that, in solid circuits, the traditional reluctance to use more than the bare minimum of active components—transistors and diodes—may have to be modified, as they may well be cheaper to form in a piece of semiconductor material than resistors and capacitors.

The session on resistors resulted in an interesting discussion—again concerned with reliability. The existence or otherwise of "rogue" components was argued, and the general opinion was that they do exist, and that the elimination of rogues—components that persistently occur outside the normal gaussian distribution—was responsible for the high cost of good quality resistors. In answer to a query on the testing of resistors guaranteed not to exceed a given tolerance during their lives, R. H. W. Burkett said that a short-term test would determine the slope of the ageing curve which would remain constant. In response to a plea for closer tolerance and more information on resistance wire, B. Walton assured the conference that the subject is under review by the British Standards Institution.

## Capacitors

In the session on dielectrics, a paper by R. A. Hill and A. W. Stirling described the design of a junction ceramic capacitor, using a thin-film dielectric. A disc of ceramic material is chemically-reduced, rendering it highly-conducting, at which point silver electrodes are fired on to opposite faces of the disc. Oxygen is then made to diffuse through the disc at high temperature, which oxidizes a layer of ceramic adjacent to each silver electrode, the oxidized ceramic being a high-resistance dielectric. The resultant component is in the form of two capacitors, the layer of unoxidized material acting as a common electrode. Each half of the unit acts as a rectifier; hence the name.

In a review of miniature capacitor development in the U.S.A. read by D. A. McLean, mention was made of multi-layer ceramic capacitors. These consist of layers of ceramic and metal laid down in the "green" state in a sheet about 1ft square. The whole mass is then fired at the curing temperature of the ceramic and diced, whereupon the edges of the metal layers are exposed. Electrodes are applied to opposite edges, providing connection between layers and attachment points for lead-out wires. This structure enables extremely thin sheets of ceramic to be used, while still retaining robustness. Size is greatly reduced.

## Mechanical Components

A relay which is designed to be compatible with modern practice in electronic equipment construction was described in a paper by E. R. Myatt. The spring-sets and coil-armature assembly are mounted separately on a printed board—a procedure which gives greater flexibility than is usually the case. The fixed and moving contacts are phosphor bronze wires, either plain or plated with a noble metal, which are fixed into holes in the printed board and soldered to the printed pattern. The moving contacts are bent to an L shape parallel to the board and brought

into contact with the fixed wires by means of a "card," actuated by the armature. Advantages claimed are flexibility of design and the ability to print connections on the same board that carries the relay.

In the same group of papers was described a multi-way socket designed to receive printed boards whose plug-pins form part of the printed wiring. The board may be inserted with a very low pressure, and contact is then made between plug and socket by the operation of a cam. The moving contacts are designed with relay-contact practice in mind, and no circuit exists between plug and socket before the cam is operated, so that the printed-wiring plug-pins are not abraded by insertion and withdrawal. In addition, by the provision of cam-operating push-rods at the front-panel of the equipment, rapid isolation of any board is possible, and this may be made automatic, to take effect if a fault develops.

The paper by J. H. Davis, D. W. Rees and I. H. Riley referred to a newly-developed silicone gel encapsulating compound. The material is intermediate

in consistency between a fluid and a gum and has the advantage that it is self-healing. A probe may be inserted to measure working voltages, etc., and on removal the hole seals. The material is applied in the form of a fluid with a catalyst added, and is cured by heating for about seven hours at a temperature between 75°C and 100°C. The reaction is not exothermic. The material is transparent and offers considerable resistance to mechanical forces.

Although it may appear that use of transistors, with their low voltages and impedances, on printed-circuit boards, would render high insulation resistance of the substrate less important, the point was made in discussion that more failures due to humidity occur at low than high voltages.

Only one or two papers in each session were read by the authors, the rest being summarized by a *rapporteur*. In view of the large number of papers presented, this was necessary to leave some time for discussion. The papers presented will be published in full in 1961 in Vol. 108, Part B of the Proceedings of the Institution.

## NEW TELEVISION TUBES

THERE are many reasons why the edges of rectangular cathode-ray tubes for television have been curved: for instance, had a 17-in, 70° c.r.t. been made with edges as straight as its smaller, but older, 14-in brother, the glass would have been thick enough to make the tube unacceptably heavy and very hard to make. However, improvements in glass-working techniques, together with the reduction in the amount of glass used (110° types) have made possible the "straightening out" of the edges of 21- and 17-in, 110° c.r.t.s into the equivalent 23 and 19-in "square-cornered" types which made their British debut (in some cases a "private" one) at the last National Radio Show.

These square tubes offer very little extra in picture height and width, but the picture area is increased appreciably over that of the 21- and 17-in c.r.t.s. For instance,

the Mullard AW59-90 has a useful screen area about 20in<sup>2</sup> greater than that of its 21-in-diagonal brothers. The radius of curvature of the centre portion of the face plate has also been much increased (Mullard AW53-89, 21-in, 724mm compared with AW59-90, 1225mm) giving a less "bulbous" appearance and a wider effective viewing angle.

The latest technique in tube-making (as noted in our review of the R.E.C.M.F. exhibition) is the introduction of the integral implosion guard. This banishes the problem of stopping the deposition of dirt on the tube face plate and the inner surface of the safety glass, and also specular reflections. These tubes have the safety "glass"—whether it is glass or acrylic resin—cemented to the face of the c.r.t. Thus no dust can enter and, because cement and safety-screen are chosen to have refractive indices near that of glass, there are only two surfaces or discontinuities at which annoying reflections can occur.

Even these reflections can be reduced. Brimar, in their Type C19AHU tube, use a glass safety cover which is sprayed with fine glass beads or "frit" to give a nearly indestructible satin-like surface. Similarly, safety-covers injection-moulded in Diakon have a slightly "rough" appearance, so reducing surface reflections.

Another advantage of the integral shield is that mounting clamps and straps are no longer necessary: the safety screen is provided with "ears" at the corners which can be clamped to the receiver cabinet. The "mask", too, can be formed by an opaque coating between the cover and face-plates.

Should any doubts be felt about the safety of this technique a glance at the photograph should prove reassuring. This c.r.t., made by Cathode Ray Tubes Ltd., was deliberately imploded. The whole of the c.r.t. screen plate is, although broken into many pieces, still firmly attached to the vacuum-formed Perspex shield: the inside is so smooth that the fingers can be dragged over the cracks without any adverse effects except mental discomfort.

All these advantages are not obtained for nothing, of course. The integral-shield tubes are difficult to re-gun because the shield or shield bonding will not withstand the prolonged high-temperature baking necessary during evacuation. This seems, though, a small price to pay.

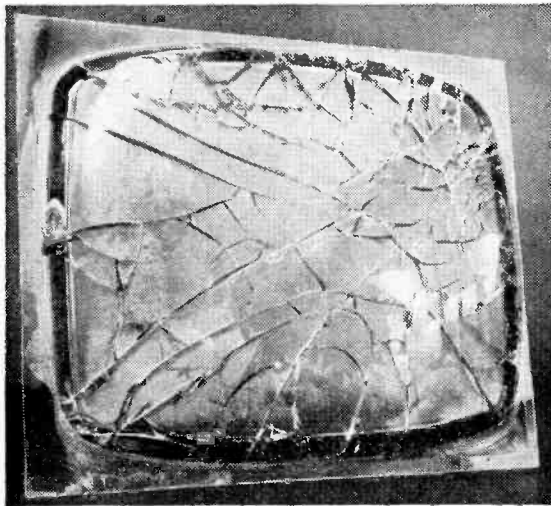

A 23-in integral-shield c.r.t. that has been deliberately imploded (Cathode Ray Tubes Ltd.)



# AN AUDIO EQUIVALENT OF THE CRYSTAL OSCILLATOR

By L. J. HILLS

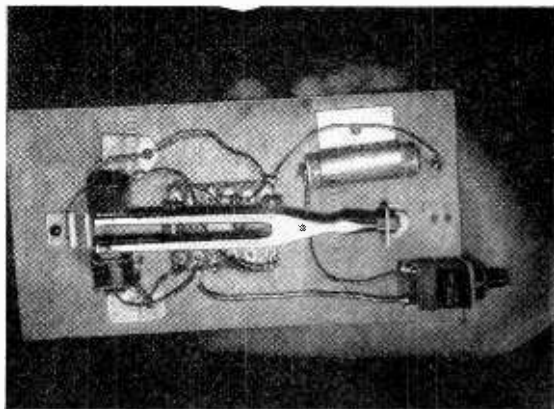

## A Portable Tuning Fork Standard

**H**AVING been concerned for many years with the design of electronic musical instruments, it has been necessary on occasions to make use of a valve-maintained tuning fork as an audio frequency standard. It was recently decided that a transistorized version of this could be more compact and could use a self-contained battery power supply. The resulting unit is so useful and turned out to be so simple that it was felt that many amateurs might like to have a similar unit, that is, an audio frequency equivalent of the quartz crystal.

The standard of accuracy will naturally depend upon the characteristics of the tuning fork used, but it is now possible to obtain tuning forks with a

temperature coefficient which is low enough for most applications for which it would be required. A small 1.5-volt pen cell battery provides ample power to maintain the fork in continuous vibration.

Most tuning forks are tuned to the equal-tempered scale and these frequencies may not be the best to use for general audio use unless one is concerned only with musical instruments.

For most general use the most convenient fork is the B, which is nominally 494 cycles per second. This can be raised to 500 cycles by very carefully filing the tips of the tines, and comparing the frequency with a known source by means of an oscilloscope and Lissajous figures. With the aid of a radio receiver comparison may be made with the standard 1000c/s tuning note provided by the B.B.C. A rough check can be made by comparison with the mains frequency. If a C fork is obtained this will be 522 cycles per second and this can be reduced to 500 by filing the crotch.

The maintaining unit is very simple and is as shown in the diagrams and photograph. In the interests of accuracy and stability it is wisest to ensure that the fork does not vibrate too violently and it is best to adjust the unit so that the fork is just maintained in vibration. This can be done by carefully adjusting the magnet spacing.

It was astonishing to find how little power was required to maintain the fork in continuous vibration. In the unit shown the collector current was 200 microamps at 1.4 volts. Some makes of fork may require rather more than this and it may be necessary to increase the transistor base current by changing  $R_1$  in Fig 1 to 47 k.

The base current is, to a large extent, dependent on the voltage developed across  $C_2$ , which is in such a direction as to increase the base current. This means that in the oscillating state, the transistor bottoms and automatic stabilization of amplitude is obtained. Initially, the base current is low, and is set by the value of the potential-divider  $R_1$ ,  $R_2$ . If the current were larger, the transistor may be initially bottomed, and the only way of avoiding this would be by an increased  $V_{cc}$ . This would then

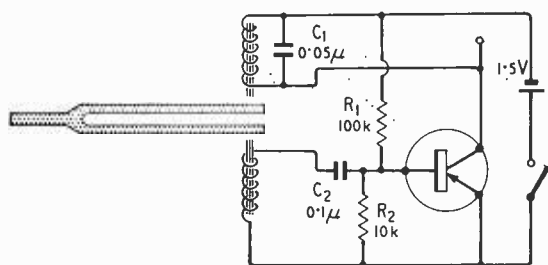

Fig. 1 Circuit diagram of the unit. Any low-power transistor may be used.

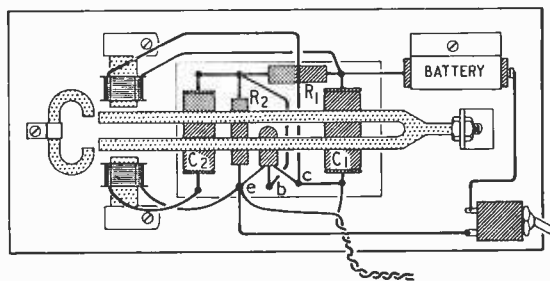

Fig. 2 Suggested layout. The baseboard may be of non-ferrous metal, or wood.

increase the amplitude of vibration of the fork, which would tend to affect adversely the frequency-stability of the unit. Almost any audio type transistor can be used with a current gain of 40 or more.

The exciting coils were obtained from a high resistance headphone and most hams will no doubt have one of these in the junk box. Alternatively, if the reader fancies his skill at winding very fine gauges of wire he may attempt to wind his own. Each coil should be wound with 2,000 or more turns of 42 s.w.g. enamelled copper wire, and should have a resistance of about 1,000 $\Omega$ . The pole pieces were cut from ordinary transformer laminations and inserted in the coils to make a tight fit. They were bent to a **L** shape for mounting on the baseboard, which can be of wood or any non-ferrous metal. The bias magnet can be obtained from a damaged meter or an old headphone or small loudspeaker unit, and should be mounted beneath the coils, not necessarily in contact with the laminations. The clearance between the pole pieces and the fork should be about .05 in, and should not be less than that required to just maintain the fork in continuous vibration.

The construction should present no difficulty. The tuning fork can be obtained from most musical instrument suppliers. It is necessary to mount the fork very rigidly so as not to allow any lateral movement other than that due to the vibration. This is done by cutting a thread on the handle with, say, a 4 B.A. die and bolting it to a mounting bracket which should be reasonably stout. The transistor maintaining unit can be mounted beneath the fork, as shown in the photograph. The precise

way of mounting the bias magnet will obviously depend on the type of magnet used and in the author's case this was done with a small metal bracket.

The use of a capacitor across the collector coil calls for some comment. This was done to tune the coil approximately to the fork frequency. The actual value will obviously depend upon the inductance of the coil. Although this capacitor is not absolutely necessary, it does improve the efficiency and the waveform. If an output very rich in harmonics is required then this capacitor can be omitted. The circuit will oscillate at some indeterminate frequency without the fork vibrating, but as soon as the fork vibration builds up, the oscillator is pulled into synchronism within a second or so. The winding sense of the coils must be correct for oscillation, but this is no problem as it is only necessary to reverse the connections to one of the coils if the unit fails to oscillate.

If an audible tone source is required, the output can be fed into a suitable amplifier and speaker. A particular musical instrument designed by the author used a whole octave of these units, the upper notes being obtained by tuning the harmonics and the lower notes by frequency division in Eccles-Jordan dividers using transistors. The result was a musical instrument that never required tuning. Its only drawbacks were the very considerable change of tone over the range of the instrument and the fact that the octaves were too mathematically correct, making it impossible to obtain those delicate chorus effects which are so important to any polyphonic musical instrument.

## ELECTRONIC WATT-HOUR SUMMATION

WITH the object of increasing reliability in summation metering for bulk supply points in electricity distribution systems and therefore reducing maintenance time, electronic methods have been introduced by Ferranti. Mechanical components have been eliminated as far as possible; contactors, for instance, are replaced by photoelectric devices. The equipment employs semiconductors

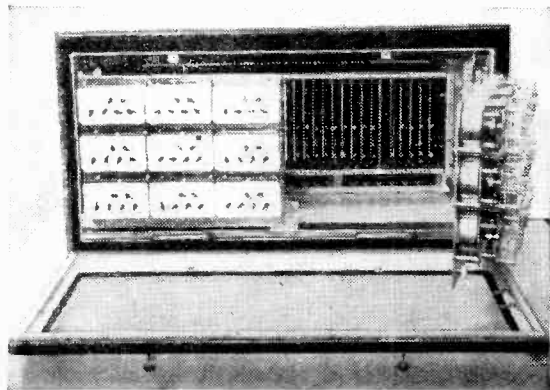

*Ferranti Electronic Summator. Printed-circuit boards, containing all the logic circuitry, are visible behind the hinged dial-panels*

throughout and is contained in a space rather less than a quarter of that occupied by conventional devices.

The input to the summator is derived from a number of changeover switches—one to each of sixteen channels. The two outputs of each switch are gated sequentially by a scanning pulse train, and used to trigger a bi-stable flip-flop, or toggle. The toggle is triggered at the arrival of a scan pulse each time a switch changes state, and will not be triggered again until the next change of state of the switch. Effects of contact bounce are thereby eliminated. The outputs of the toggles are used to drive stepping-motors, which register the number of pulses received in each channel on check dials. A common highway is also fed by the differentiated, rectified toggle outputs and used to drive a stepping motor check dial, which displays the total number of pulses received on all channels.

To avoid the necessity for long contact-dwell time or a high scanning rate, the outputs of the switches are not directly gated, but are stored in toggles, thereby ensuring that all pulses are gated. When the changeover switches are replaced by photoelectric sensing elements, this input toggle employs two photo-transistors, each being triggered in succession by a light source and rotating shutters.

The advantages offered by the new equipment are increased flexibility, absence of mechanical deterioration, and negligible power consumption—all transistors are operated as switches. Ease of maintenance is greatly enhanced, and in the majority of cases, merely necessitates the changing of a printed card.

# MANUFACTURERS' PRODUCTS

## NEW ELECTRONIC EQUIPMENT AND ACCESSORIES

### *Ionization Detector*

THE onset of ionization in a cable or capacitor is often indicative of a forthcoming failure. Similarly in the testing of these items discovery of the point at which ionization occurs can often act as a valuable guide to the standard of construction: ionization occurring at a relatively low voltage in one sample of a batch usually indicates the presence of a gas-filled space in insulating material. One common test procedure involves isolation of the object to be tested: this has disadvantages where a component or cable is in use.

The BICC-Addison Acoustic Corona Detector uses a probe containing a transducer for the detection of the noise produced by ionization in gases in voids in cables,

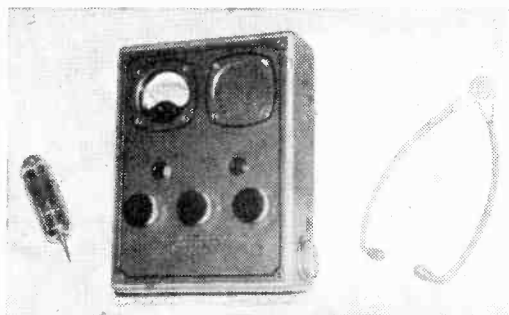

BICC-Addison ionization test-set receiver 7 x 8½ x 2½ in. Shown also is acoustic probe and headphones.

insulators, capacitors, etc. The output from the probe, which is held against the object under test, is passed to a 5-stage transistor amplifier which incorporates a switched filter to reduce mains "hum" or other unwanted noises and the output is fed to either headphones or a loudspeaker.

Accessories include an insulating rod for safe use of the acoustic probe on high-voltage equipment and inductive and capacitive probes which may be employed for cable tracing and identification.

Power is supplied by two No. 8 torch batteries and the weight of the complete set in its carrying case is 6lb 7oz.

Addison Electric Co. Ltd., 10-12, Bosworth Road, London, W10.

### *100-W p.e.p. s.s.b. Transmitter-receiver*

THE Redifon Type GR410 transmitter-receiver covers the 3-18Mc/s band, providing operation on four preset, crystal-controlled spot frequencies (eight channels on s.s.b.) with single-sideband or a.m. telephony and c.w. or m.c.w. telegraphy. Transistors are used extensively—the only valve stages are the power amplifier and driver—and the power consumption is low (only 7W on "receive"). Full remote control facilities (including channel and type of emission) are provided by fitting an extra unit to the front of the set, when a 100yd separation of the GR410 and its control box can be achieved by using standard cables. Where control from a nearby position is required (within the same room as the GR410, or mobile use, for instance) the L-shaped unit carrying the

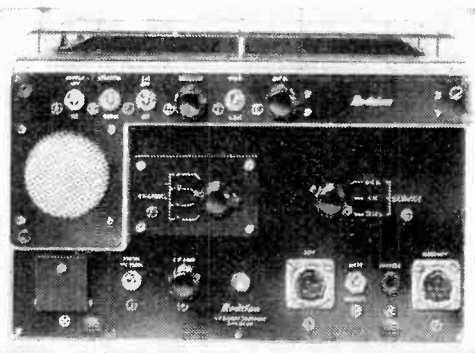

Redifon's GR410 transmitter receiver.

loudspeaker and operating controls can be unclipped and mounted on a separate panel.

Modular construction is used and the output stage consists of three 6146 valves in parallel—thus aiding reliability. "Vox," or voice-operated switching, operation is provided, together with circuits to prevent sound from the set's loudspeaker changing the set from "receive" to "transmit."

Receiver sensitivity is better than 1µV for 10dB signal-to-noise ratio on s.s.b. and the "third" method of s.s.b. generation and reception is employed.

Redifon, Ltd., Broomhill Road, London, S.W.18.

### *Industrial Pen Recorders*

THE Officine Galileo range of direct-writing pen recorders are now available in England.

The use of interchangeable preamplifiers enables the study of many different types of phenomena to be undertaken by the use of a single instrument. Instruments are available having up to 32 channels, and employing either ink-pens or hot styli. In the multi-channel equipment, photographic recording may be used, which allows the higher frequency components—up to 800c/s—of waveforms to be examined. Response time

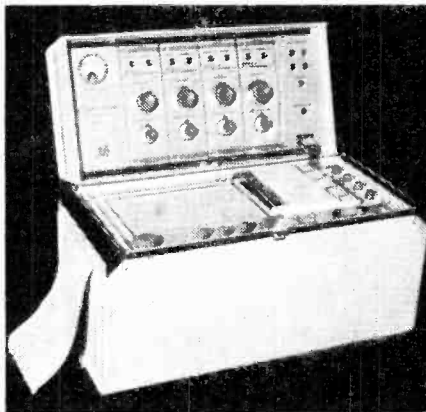

A 4-channel industrial pen-recorder by Galileo.

of the recorders is 0.01 second, and paper speed is variable from 2.5mm/sec. to 100mm/sec. Details may be obtained from Leland Instruments, 145, Grosvenor Road, Westminster, London, S.W.1.

### Miniature Mains Connector

DESIGNED to combine small size with safety the Belling-Lee Type L1436 three-pole mains connector is rated at 1 to 2A, 250V r.m.s. The plug body is moulded from black nylon and is thus practically unbreakable: its cover is transparent so that visual inspection for satisfactory cable connection can be carried out without taking it apart. Cables up to  $\frac{1}{4}$ -in diameter are clamped firmly in the cord grip and the silver-plated pins are shrouded to avoid danger of contact. The plug itself disengages easily from the socket on application of a pull to the cable—thus accidental damage to equipment, cable, plug and people is avoided.

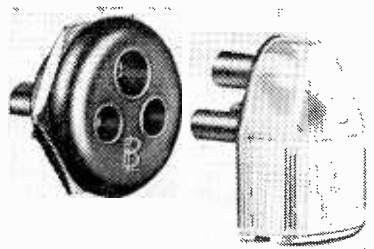

Miniature 3-pole mains connector is about  $1 \times \frac{3}{4} \times \frac{7}{8}$ in—socket is 1in dia and  $\frac{5}{8}$ in deep, overall

The black phenolic-resin socket for chassis mounting requires a single hole 0.77in diameter and has an anti-twist spigot: again the contacts are completely shrouded for safety.

Belling & Lee, Ltd., Gt. Cambridge Road, Enfield, Middlesex.

### “Dry-Reed” Relays

A USEFUL life of 20 million operations and a contact resistance of  $0.03\Omega$  are features of “dry-reed” relays produced by B. and R. Relays, Ltd., Temple Fields, Harlow, Essex. The relays are mounted on either 8- or 14-pin bases, and can consist of up to 6 reeds. Operating power is 0.1W for 1 reed and 0.9W for 6 reeds.

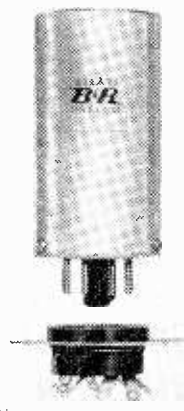

One of the range of B. and R. dry-reed relays. Diameter  $1\frac{1}{4}$ ”, height  $3\frac{1}{4}$ ”.

### Solid-state Industrial Controls

ANALOGUE computer systems for industrial plant control are to be marketed in the U.K. by Hagan Controls, Ltd., 14, Grosvenor Place, London, S.W.1. The equipment, known as Powrmag is comprised of completely solid-state elements—magnetic amplifiers and semiconductors.

A system consists of the output transducer, which

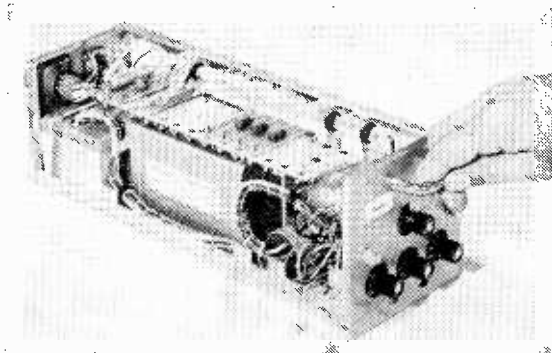

One of the range of computer controls made by Hagan Controls.

converts the physical phenomena to be controlled into a voltage, the magnetic amplifier analogue computer control unit, which has variable characteristics obtained by plug-in components, a remote control station, and the output device, which may be electrical or mechanical.

### Radio-telephone Equipment for Small Craft

INTENDED for small fishing vessels and harbour craft, the Marconi “Kestrel” covers the band 190-4500kc/s, and delivers a power of 36-50W into a 20ft whip aerial, or a 60ft wire aerial.

The receiver has facilities for use with Consol navigation equipment, and may be used with direction-finding equipment—either a radiogoniometer and fixed aerial, or a rotating loop.

The transmitter may be operated on either the duplex or simplex system and provides eleven spot frequencies in the band 1.6-3.8Mc/s. Metering is provided to check for correct working. The power unit will work from either 12V or 24V batteries. Information obtainable from Marconi International Marine Communication Co., Ltd., Marconi House, Chelmsford, Essex.

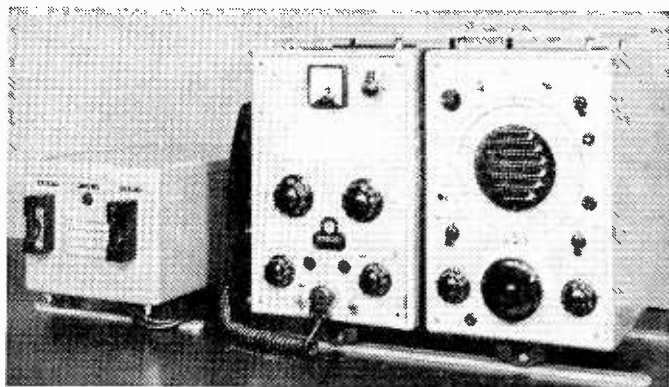

The Marconi “Kestrel” radiotelephone equipment. From left to right—Power Unit, Transmitter, Receiver.

# Elements of Electronic Circuits

## 28.—Logarithmic Amplifiers

By J. M. PETERS, B.Sc. (Eng.), A.M.I.E.E., A.M.Brit.I.R.E.

**T**HE logarithmic amplifier develops an output which is proportional to the logarithm of the input. Fig. 1 shows an ideal straight-line amplifier response curve with input voltage plotted on a logarithmic base:  $v_{out} = \log v_{in}$ . Let us now examine how an amplifier can be made to produce a logarithmic response. One method uses the process known as successive detection where the output from every stage of the amplifier is detected and added to that

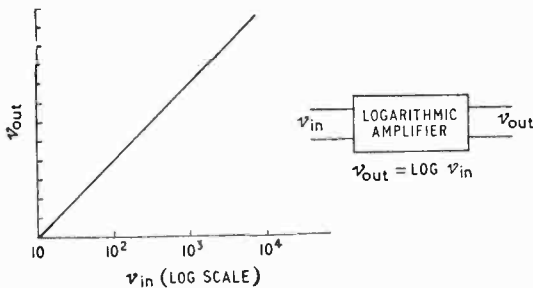

Fig. 1

of successive stages. To overcome the effect of time delay in successive stages it is necessary to apply the output from every stage to the appropriate section of a delay line thus ensuring that all the detected voltages are in time coincidence for summation purposes.

Fig. 2 shows in diagrammatic form how this is done in a five-stage amplifier (only parts of the circuit essential to the description are shown). A feature peculiar to this type of amplifier is that each stage is allowed to saturate or "overload". Every stage

is also arranged to have the same stage gain ( $m$ ) which implies that each valve has to have a similar  $g_m$ . We will now show why the action is logarithmic. Let the output voltage per stage at saturation =  $v$  for an input voltage  $v/m$ . This output voltage creates a rectified voltage  $v_1$  across the terminating impedance of the delay line. If we now assume that our amplifier has five stages with each stage having a stage gain of  $m$  at saturation, to make the last stage saturate the input to the first stage will therefore have to be  $v/m^5$  (see Fig. 3). The rectified outputs to the delay line will be  $v_1$  from the final stage together with contributions from the preceding stages thus:—

- $v_1/m$  from the fourth stage
- $v_1/m^2$  from the third stage
- $v_1/m^3$  from the second stage
- $v_1/m^4$  from the first stage

In other words:—

Input	Output
$v/m^5$	$v_1 + (v_1/m) + (v_1/m^2) + (v_1/m^3) + (v_1/m^4)$

Now let us increase the input to the first stage to  $v/m^4$ ; this will make the last stage but one saturate. The rectified output to the line will be  $v_1$  from the last stage (as before) together with  $v_1$  from the last stage but one. The contribution from the preceding stages will be:—

- $v_1/m$  from the third stage
- $v_1/m^2$  from the second stage
- $v_1/m^3$  from the first stage

In other words:—

Input	Output
$v/m^4$	$v_1 + v_1 + (v_1/m) + (v_1/m^2) + (v_1/m^3)$

Increasing progressively the input voltage to the

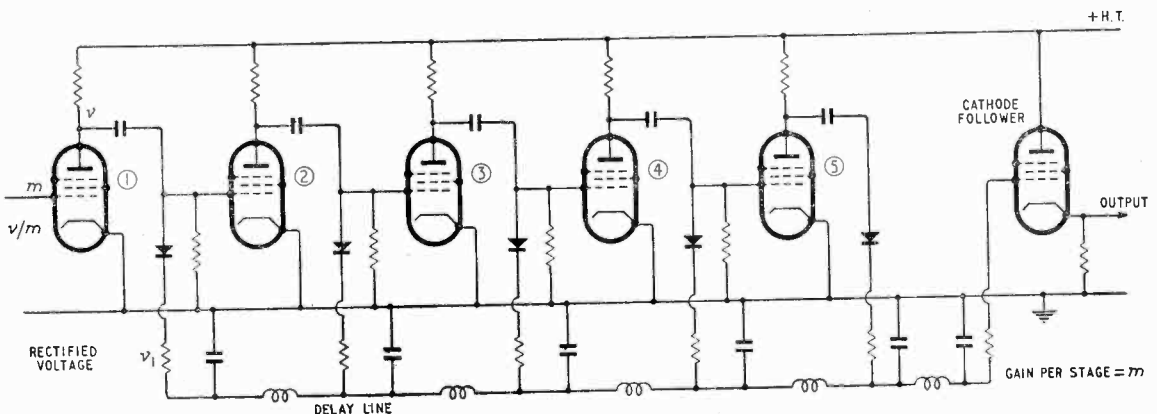

Fig. 2

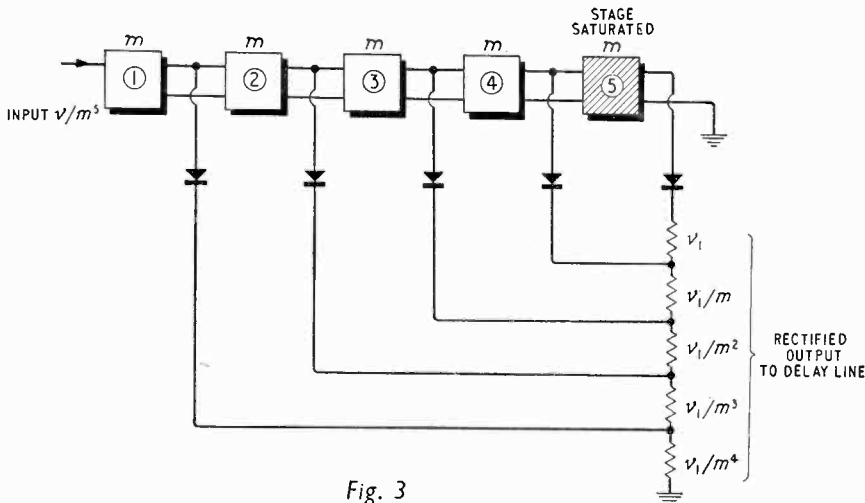

Fig. 3

first stage will cause each stage to saturate in turn. A table can now be constructed thus:—

Input	Output	Stages Saturated
$v/m^5$	$v_1 + (v_1/m) + (v_1/m^2) + (v_1/m^3) + (v_1/m^4)$	5
$(v/m^5) \times m = v/m^4$	$v_1 + v_1 + (v_1/m) + (v_1/m^2) + (v_1/m^3)$	5 4
$(v/m^5) \times m^2 = v/m^3$	$v_1 + v_1 + v_1 + (v_1/m) + (v_1/m^2)$	5 4 3
$(v/m^5) \times m^3 = v/m^2$	$v_1 + v_1 + v_1 + v_1 + (v_1/m)$	5 4 3 2
$(v/m^5) \times m^4 = v/m$	$v_1 + v_1 + v_1 + v_1 + v_1$	5 4 3 2 1

Now if  $m$  is made very large, the rectified output will be seen to increase according to an arithmetical progression  $v_1, 2v_1, 3v_1$  etc. as the input is increased in a logarithmic fashion. The output is then proportional to the logarithm of the input.

Another type of logarithmic amplifier makes use of an entirely different principle. Referring to an early article which discusses the differentiation of a square wave, we are reminded that, provided that the period of the square wave is very much greater than the CR-product or time constant of the differentiating circuit, the voltage appearing across the resistor takes the form of a decaying exponential curve (See Fig. 4).

$v_1 = v_0 \exp(-t_1/CR)$   
 $v_0/v_1 = \exp(t_1/CR)$   
 $\therefore CR \log_e(v_0/v_1) = t_1$   
 where  $t_1$  is the time taken for the input voltage  $v_0$  to decay to a level  $v_1$ .

Let us now consider an amplifier based on this principle. The input waveform is assumed to be square and of a low p.r.f. It is ap-

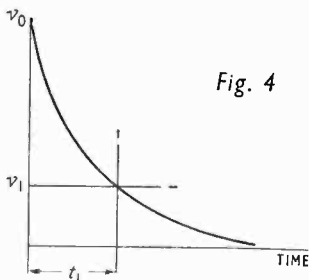

Fig. 4

plied to a differentiating circuit having a time constant much shorter than the period of the wave. The differentiated square wave is fed into a d.c. amplifier which provides a substantially linear amplification for an input ranging from zero to the reference voltage  $v_1$  (See Fig. 5). The output from the d.c. amplifier is fed to a trigger circuit which is "switched on" all the time the amplifier output exceeds  $v_1'$  (the amplified reference voltage  $v_1$ ). The width of the pulses from the trigger circuit, which occur at the p.r.f. of the original square-wave input, is constant and equal to  $t_1$ .

If we rectify these pulses, the rectified d.c. component is proportional to  $t_1$  and clearly dependent on the voltages  $v_1'$   $v_1$  and hence  $\log_e v_0$ . The output is then proportional to the logarithm of the input. Attention is drawn to the article on Multiplication and Division (No. 22, Feb. 1961) where other arrangements having a logarithmic input/output law are used in multiplying and dividing circuits.

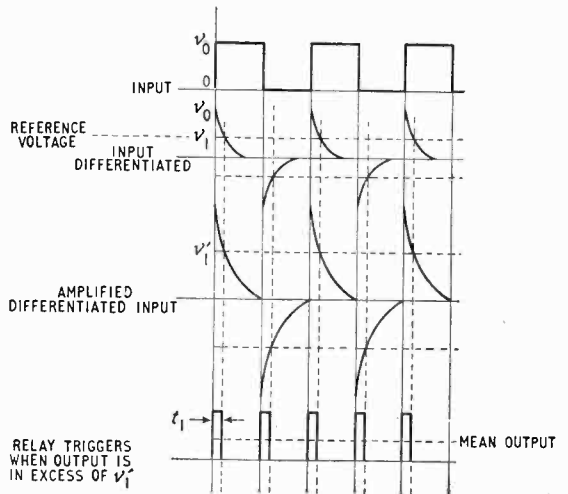

Fig. 5

Logarithmic amplifiers of the current-operated type are often found in the field of reactor instrumentation. Modern radar sets use the logarithmic amplifier to reduce the enormous differences between the heights of target echoes, at the same time reducing rain and sea clutter returns almost to noise level. This is convenient for a p.p.i. presentation for it ensures that, although target echoes are reduced in amplitude, the background is kept at a constant level at all ranges.

Suppose a logarithmic amplifier is fed with r.f. signals of different amplitudes but having the

same percentage modulation. The outputs will be the same except that they are superimposed on different values of rectified r.f. (These d.c. levels are proportional to the logarithm of the mean r.f.) Radar returns comprise echo, rain and sea clutter in addition to noise, all of which combine to form complex modulated signals of the same percentage modulation which are applied to the input of the logarithmic amplifier. At the output, although the d.c. components will be proportional to the logarithm of the mean input level at the particular range, the amplitude of the fluctuation will be constant at all ranges. The d.c. components can be easily removed. The target echo which is superimposed on the noise does not fluctuate and therefore remains clear of the background. In practice it is necessary to filter the radar returns to get rid of a low-frequency component, for the d.c. levels actually fluctuate at the scan rate of the aerial. This is

because the amplitude of the sea clutter return varies according to the aspect of the aerial to it.

### Conclusion

This instalment concludes the present series of articles on the elements of electronic circuits. Throughout the series my aim has been to try to give a simple explanation of the operation of some of the more basic electronic circuit devices. Although primarily intended as an introduction to the subject for the student, it is hoped that the notes may have refreshed the memory of the more advanced reader. In conclusion, I would like to express my thanks to the members of the *Wireless World* editorial staff for their helpful suggestions and criticisms, and to acknowledge the assistance I have received from the many standard reference books and other published matter in the preparation of the series.

## BEDFORD RELAY

### COLOUR TV DEMONSTRATED ON WIRE DISTRIBUTION SYSTEM

THE town of Bedford, although it lies only some 50 miles from London, is particularly unfortunately situated for television reception. Aerial arrays have to be large,

complex and carefully set up—this, of course, is expensive—and, even then, completely satisfactory results are not always achieved.

Since the spring a Multisignals r.f. relay system has been operating with equipment made by E.M.I. The aerials are mounted on top of Ravensden Water Tower, outside the town, and a four-mile-long underground coaxial cable with repeaters every quarter of a mile carries the amplified signals down into Bedford. A wideband system in which the distributed-amplifier-type repeaters cover Channels 1 to 13 and v.h.f./f.m. radio is employed and Radio Luxembourg is received, converted to Band-II f.m. and passed into the network. B.B.C. Channel I and I.T.A. Channels 9 and 11 are available (London and East Anglia) on their original frequencies. Some idea of the poor signal available in Bedford itself may be gained from the fact that even at the relay receiving site, 379ft above sea level, signals of only 150 to 300 $\mu$ V are obtained.

A feature of the opening was the demonstration of B.B.C./N.T.S.C. 405-line colour on two experimental Ekco receivers, one taking its signals from the network, the other from a local aerial. Whilst the receiver working from the network gave, as expected, an impeccable picture, the other was extremely noisy; so bad, in fact, that the noise was evident as twinkling colour, not just background disturbance. Whenever any local interference was generated the picture was blacked out completely and ignition interference was troublesome.

Initially the service was available to 4,000 of the 19,000 houses in Bedford; by the end of the year it is expected that wiring will be extended to another 6,000 dwellings. Charges for the aerial service range between 16s 6d per month for two years and 11s 6d. thereafter and £5-down connection fee and an annual charge of £6 10s, the viewer providing his own standard receiver.

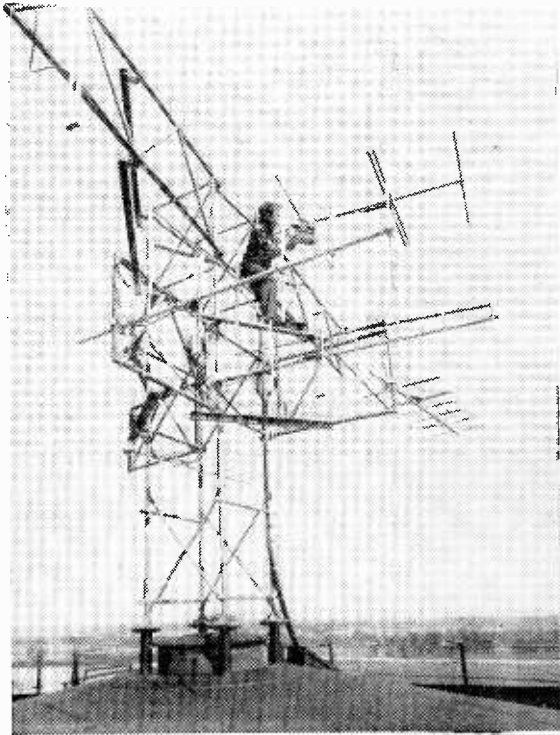

Aerial arrays on top of Ravensden Water Tower.

Typical repeater-amplifier mounted on the wall of a radio-and-television dealer's shop in Bedford.

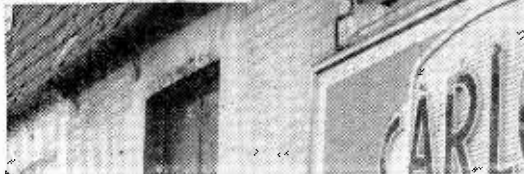

# RANDOM RADIATIONS

By "DIALLIST"

## A Unique Award

FOR the very first time the award of an "Emmy" has been made to two non-American firms by the American National Academy of Television Arts and Sciences. An "Emmy" is the TV equivalent of the film-world's "Oscar." The British firms are the English Electric Valve Company and Marconi's Wireless Telegraph Company. An "Emmy" was also presented to R.C.A. All three firms have been concerned with the development of the 4½-inch image orthicon tube. The first version of this, which did not get beyond the laboratory stage, was produced by R.C.A. The English Electric Valve Company saw its possibilities and with Marconi's pioneered the commercial development of the tube and of its associated cameras, the Marconi Mark III and Mark IV. It is now exported to every part of the world where there is a television service, including the United States, for it has proved itself superior to any other in many ways. The resolution, the signal-to-noise ratio and the reduction in spurious effects are unmatched. Work on the tube began ten years ago and as long ago as 1954 it was showing its qualities in the B.B.C.'s Lime Grove Studio E. That was in the Marconi Mark III

camera; now in the Mark IV camera it has proved itself a world-beater.

## Electricity from the Sea

THE island of Mauritius gets a pounding by huge Indian Ocean waves during the greater part of the year. At present the Hydraulics Research Station of the D.S.I.R. is working on a project to make use of their energy for generating electric power. The idea is to construct a ramp over which the waves would climb to fill a lagoon above sea level on the far side. This lagoon would be drained through turbines of a type which need only a small head of water, and these would operate generators. Scale models have shown great promise and it is believed that worth-while quantities of power can be produced by this method of harnessing the energy of sea waves. The first station to be erected is expected to generate about 9,000kW, and later the output will be increased about five times. In some ways it's surprising that the enormous energy of tides and great waves has not already been made to do useful work. French engineers are, I believe, developing a plan to use tidal energy for the generation of electricity somewhere on the coast of northern France. One day, I expect, we'll find a way of using the

big tides of the Bristol Channel and possibly the tidal race through the Pentland Firth.

## French-English Power Link

BY the end of this year the power link between this country and France should be completed. The peak periods in the two countries are different, so that it will often happen that France has electricity to spare for us or that we can supply her when her need is great and ours comparatively small. At first sight it seems rather curious that the cables between the two countries will carry d.c. But no way could be discovered of phasing up satisfactorily if a.c. were used. The 38-mile undersea link will be connected to converter stations at Lydd in Kent and Echinghen near Boulogne. When the system gets going 160MW of power will be transferable between one country and the other. The link will carry 200kV d.c. and 800A. One can't help wondering what the I<sup>2</sup>R losses will be—but that, of course, has all been allowed for. So too has the possible effect of magnetic fields on the compasses of passing ships; the go and return cables will be closely spaced throughout their length to keep loop area to a minimum.

## Link with the Early Days

SO Magnet House is to be demolished soon after the end of this year. I'm sorry, for I've always regarded it and Marconi House as landmarks in wireless, television and electronics. I suppose that a new and larger building will arise from its rubble, but I sadly fear that it will be of the "pile of boxes" style that is so much in vogue nowadays. Both Magnet House and Marconi House had close associations with the British Broadcasting Company, as it was before its title became British Broadcasting Corporation. The B.B.C.'s entire staff was at first housed in one enormous room in Magnet House and it was from Marconi House that 2LO made its first broadcasts. That again was a one-room business. All the speakers and other entertainers sat at the back of it, waiting for Arthur Burrows to call them to the microphone. His

### "WIRELESS WORLD" PUBLICATIONS

	Net Price	By Post
<b>PRINCIPLES OF SEMICONDUCTORS</b> M. G. Scroggie, B.Sc., M.I.E.E.	21/-	21/11
<b>RADIO DESIGNER'S HANDBOOK</b> Edited by F. Langford-Smith, B.Sc., B.E., Senior Member I.R.E. (U.S.A.), A.M.I.E. (Aust.). 4th Edition (revised)	55/-	57/3
<b>PRINCIPLES OF FREQUENCY MODULATION</b> B. S. Camies	21/-	21/10
<b>RADIO VALVE DATA</b> Compiled by the staff of "Wireless World." 7th Edition	6/-	6/10
<b>ELECTRONIC COMPUTERS. Principles and Applications.</b> T. E. Ivall. 2nd Edition	25/-	26/-
<b>INTRODUCTION TO LAPLACE TRANSFORMS for radio and electronic engineers.</b> W. D. Day, Grad.I.E.E., A.M.Brit.I.R.E.	32/6	33/6
<b>BASIC MATHEMATICS FOR RADIO AND ELECTRONICS</b> F. M. Colebrook, B.Sc., D.I.C., A.C.G.I. Revised by J. W. Head, M.A. (Cantab.). 3rd Edition	17/6	18/6
<b>PRINCIPLES OF TRANSISTOR CIRCUITS</b> S. W. Amos, B.Sc.(Hons.), A.M.I.E.E. 2nd Edition	21/-	22/-
<b>LEARNING MORSE 13th Edition</b> H. F. Smith, former editor, "Wireless World"	1/6	1/10

A complete list of books is available on application.

Obtainable from all leading booksellers or from

ILIFE BOOKS LTD., Dorset House, Stamford Street, London, S.E.1.



name won't ring any bells for the younger generation; but he was the backbone of the early programmes and beloved by the children as Uncle Arthur, the originator of Children's Hour.

### A Big Ear

THEY always do things on a grand scale in the United States, especially when the government is finding the necessary dollars. Now comes the news that they are putting up in Maine the biggest horn-type aerial in the world. With a length of nearly 200 feet and a height of just under one hundred it will dwarf all others. It has a double purpose. First of all it will be used in experiments in beaming signals on to orbiting satellites, in which our G.P.O. and certain European authorities are co-operating. Its other job will be to pick up the small signals relayed by them. The whole thing is to be encased in an enormous balloon to protect it from climatic damage. It is rather expected that eventually it may become part of a world-wide system of telephone and television communications depending on reflection from satellites.

### Doing a Good Job

THE Pilkington Committee is taking its task very seriously and when it comes out its report should be of real value. Recently Sir Harry Pilkington and three members of the Committee paid a visit to Canada and the United States in order to obtain first-hand knowledge of some of the television methods in use there. Among the subjects they discussed were colour television, educational broadcasting and pay-as-you-view TV. They also visited Etobicoke, Toronto, to see for themselves how the experimental subscription service of wired television is panning out there. One only hopes that when they come to write their report they won't be unduly swayed by the clamour for this and that by certain bodies, who don't seem to have done enough deep thinking about some of the things they so vehemently advocate.

**Correction.**—We have been asked to point out that on page 83 of the advertisement section of our July issue a misplaced line of type in the announcement of D.I.A. "Electro-technik" directed inquiries to Berlin. All inquiries from the Commonwealth should in fact be addressed to Telemechanics Ltd., Totton, Southampton.

WIRELESS WORLD, AUGUST 1961

# COMPONENTS — for CONTROL

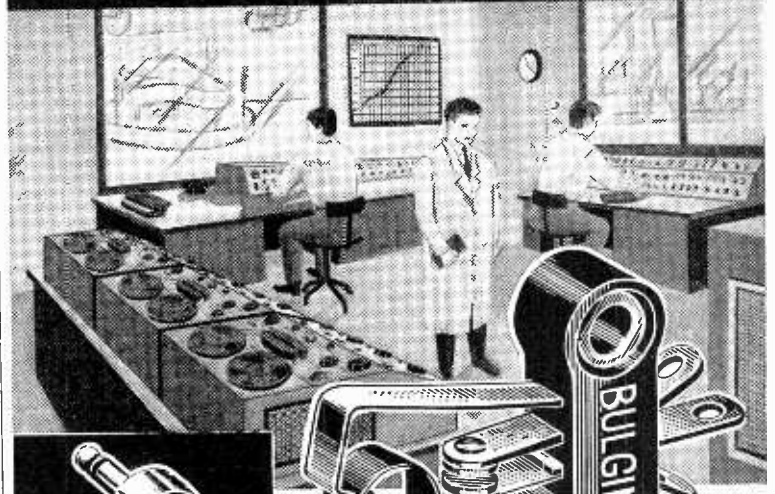

LIST NO. P.535 - 536



LIST NO. K.462



LIST NO. J.19



LIST NO. K.460+K.461

## INSTANT CONTROL IN FIDELITY RECORDING

... is assured when Bulgin Components are incorporated in the equipment. Manufactured from highest grade materials and assembled by skilled staff, with arduous testing of random picked batches ensures their constant high standard of workmanship. P.535 chrome plated and P.536 hard gold plated, are new screened, side entry Jack Plugs. K.462 is a new collet fixing moulded Bakelite knob for really vibration proof fixing. J.19 one of a range of very popular panel Jacks; and K.460 another new collet fixing knob which can be supplied with or without a skirt. K.461 being the skirt illustrated, and above illustrated is our ever-popular Open Blade Micro Switch LIST NO. S.695 having numerable uses in Tape Recorders, Venders, Computers, etc.

### CATALOGUE

Our complete range of Electronic Components is illustrated with full technical details in our comprehensive catalogue No. 201/2nd edition/C available price 2/6d. post free, or free to Trade Letterhead or Order.



A. F. BULGIN & CO. LTD., BYE PASS ROAD, BARKING, ESSEX  
Telephone: RIPpleway 5588 (12 lines)

Over 10,000 Electronic Components

By "FREE GRID"

## Ateleorasis

I DON'T think you will find the word of my title in even the very largest dictionary, but those of you who have studied the language of Socrates will have no difficulty in recognizing it as meaning "televisionless." If this word has succeeded in making you read what I have to say, I shall have achieved my object, for I want to talk to you about the deplorable state of hospital wireless which has recently been forced upon my attention.

Nowadays I suppose we take hospital wireless for granted as far as sound radio is concerned, and imagine that hospital TV is quite out of the question except for a set in wards where the patients are not completely confined to bed all day.



*The shape of things to come ?*

At any rate, I thought this until quite recently when a sudden emergency caused Mrs. Free Grid to be removed at dead of night to one of our largest and oldest-established hospitals.

On visiting her, I was astonished to find that her ward, in common with all the other female wards, was provided only with the old-fashioned 'phones of yesteryear in which the headbands seem to be designed specially for getting entangled in

ladies' hair. I quickly replaced her 'phones with a modern pair of the stethoscope type where there is actually only one "earpiece" which is situated at the junction of the two arms.

Naturally this immediately caused discontent among the other ladies in the ward (you know what women are) whose husbands were promptly put in the doghouse for not being as attentive to their wants as I was to Mrs. Free Grid. It astonishes me that 'phones of this type or of the lorgnette type have not been provided in ladies' wards before this. I think even men patients would find them more comfortable.

But it was the complete absence of TV which surprised me. Surely in these days it would be possible to provide a separate TV screen for each bed. The sets could be suspended from the ceiling, at an angle, by means of a special bracket as shown in my sketch. Of course, they would need no loudspeakers or auxiliary audio apparatus as the "sound" part of the programme would come over one of the normal headphone channels. (This would cheapen the sets, and a further economy could be effected by providing each set with two display tubes presenting a picture to beds on opposite sides of the ward as in my illustration. In fact, still more money could be saved by feeding all the sets in one ward from a common power pack, all high-voltage wiring being run safely above the ceiling of the ward.)

Naturally, all this would cost money, but since TV would be as much a therapeutic measure as some of the other hospital treatment it would probably be an economy in the long run. It would, I feel sure, empty beds quickly even if only on account of the poorness of some of the programmes we get nowadays.

Without doubt I shall be denounced as an irresponsible dreamer, just as were Harvey and Lister in their day, but I am used to that. No doubt some of you will have better ideas than mine of suspending the sets from a ceiling bracket, and if so please let me have them.

## Jiggered

IT is always a pity when a beautiful scientific theory is shattered by a nasty little fact, but all the same I feel honoured to be corrected by so eminent a radio authority as Captain H. J. Round concerning the origin of the word jigger (July issue).

It is all the greater pity because I had abandoned the theory I expounded in the June issue. I had decided that Marconi used the name jigger because he had noted the resemblance between the electrical oscillatory motion in the windings of his r.f. transformer and the rapid up and down oscillatory motion of the Irish jig and Italian Giga.

I am a bit surprised at Captain Round's revelation that the large i.f. chokes hanging by ropes from the roof at Clifden were named "Crippens." The misguided little doctor didn't achieve notoriety until late 1910, by which time, surely, the Clifden station had been in existence several years.\*

\* True, but it did not then cease. In fact it was operating up to 1922.—Ed.

## Palæalgia

I HAVE suddenly remembered that these words will appear in August, the month when the National Radio Exhibition once more opens its doors. I, who have seen so many of our radio shows, cannot help thinking that present-day exhibitions lack the excitement and "romance" of those held in the 'twenties when there always seemed to be a new circuit for us to try out.

In 1926, for instance, it was Sir Oliver Lodge's N circuit. What became of that I wonder? In that year too came W.W.'s famous "Everyman Four" receiver. But I expect that at the exhibition of 2000 A.D.—only 39 years ahead—there will be palægic lament for the days of 1961 before broadcasting had become a mere adjunct of the G.P.O. telephone service.

As for the word in my title, it can be translated as "pain for the past" or, more poetically, as "heartache for scenes of long ago." It is not a very elegant word I'll admit, but surely more accurate than the misleading B.B.C. word "nostalgia" which means "homesickness" and nothing else. No doubt some of you Homeric scholars can think of a better word than mine and, if so, I shall be glad to hear of it; but it must be reasonably compact.